



Control system

A wide range of control solutions, management, supervision and monitoring for VRF-HVRF CITY MULTI systems. For high comfort, low consumption and optimized energy efficiency. Quality and technology ready to serve companies and customers.





Introduction

Using an efficient and practical control system plays a crucial role in optimising the performance and reducing the energy consumption of VRF-HVRF CITY MULTI air conditioning, heating and domestic hot water production systems. Ensuring that a VRF system is controlled correctly will result in superior comfort, lower consumption and better energy efficiency. An incorrectly controlled VRF system will not be able to operate as effectively and efficiently as it is designed to: each degree centigrade variation from the requested operating temperature may increase energy costs by as much as 5%. Mitsubishi Electric offers an extensive range of technologically advanced remote and centralised control systems to allow integrated control and adjustment, with the same superior reliability and innovation as VRF-HVRF CITY MULTI systems. Using one of the wide choice of controller options available will

ensure that the air conditioning system functions both correctly and efficiently, and maximises comfort.

Advanced MELANS (Mitsubishi Electric's Air-conditioning Network System) control technology offers the same modularity as VRF-HVRF CITY MULTI variable refrigerant flow systems. The advantages and benefits of these systems are clear right from the start: they are extremely simple and foolproof to install, as the connections between the different units and devices in the installation consist of single, non-polarised two-core cables over which all the components in the system exchange data and operating parameters and which also carry all control and setting signals generated by users. These systems are diagnosed using specific software applications and tools developed by Mitsubishi Electric.

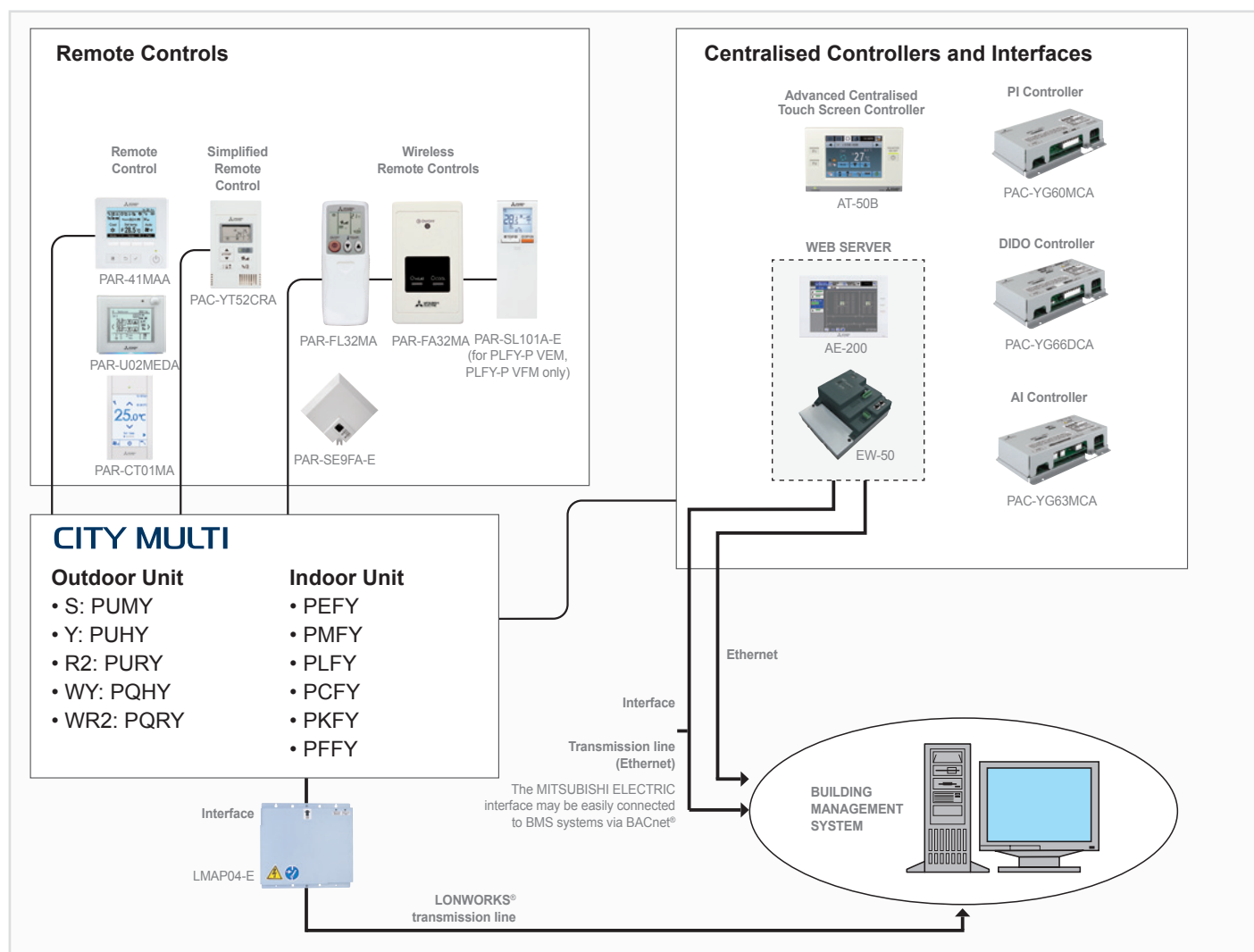



Local control and adjustment

The local settings controller is a wired controlled (or infra-red remote controller) installed in the same room served by the associated indoor unit, which allows the user access to the typical functions of a Mitsubishi Electric VRF-HVRF CITY MULTI system.

This type of connection may be used for the local control of one or more indoor units (up to 16), and represents the first point of contact and control between the user and the installation.

The main functions typically available with this type of controller are:

- ON/OFF
- Select operating mode
- View and set temperature
- View ambient temperature
- Fan speed
- Air flow direction

EXAMPLE OF WIRED CONNECTION (MA controller)

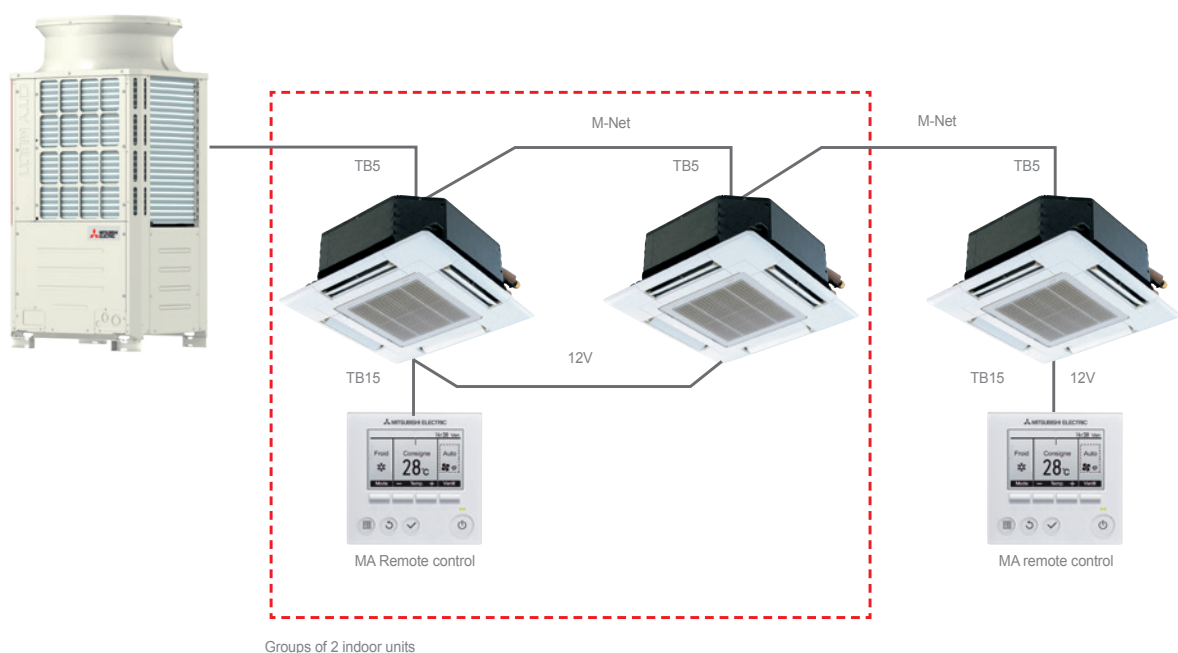

Groups of 2 indoor units

Centralised control and adjustment

In a complex and large system architecture, all the information relative to the installation is routed through and processed by advanced centralised controller and supervisor devices designed to ensure impeccable comfort, minimise energy consumption, automate routine adjustment functions and make personalised adjustment simpler and more intuitive for users, and to do this securely and safely.

All of this is based on a single basic principle: instead of the user having to physically check the installation to make sure that it is operating correctly, all the information relative to the installation is made available to the user, wherever he or she may be, in the most simple and intuitive form possible.

On the one hand, individual users must naturally have the freedom to set the air conditioning parameters to suit their own preferences from remote controllers connected to each indoor unit, while on the other, the building administrator must be able to supervise the entire hierarchical structure of the air conditioning installation as if it were a single device. The concept of centralised control over all the devices installed in the field is the answer to these needs, and in this case, the indoor units in the installation share data continuously over the M-Net communication bus.

CENTRALISED CONTROL AND ADJUSTMENT

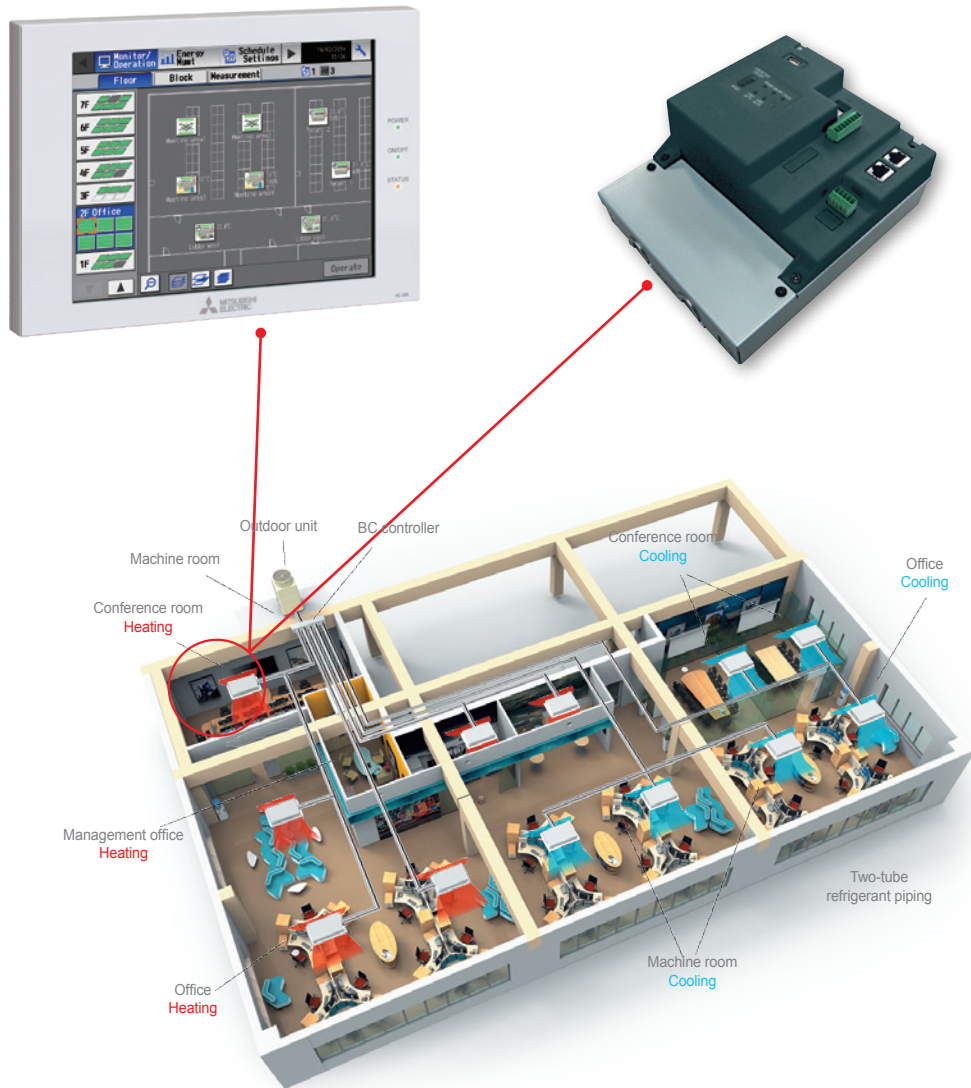

Remote control and adjustment

Remote control and adjustment means the ability to manage the indoor units of an air conditioning system — both individually and collectively — remotely via the cloud from any internet access point and, therefore, without direct access to the network infrastructure of the building.

This capability brings the flexibility of local control and adjustment — with access to all typical control functions for indoor units — and the advanced centralised management functions offered by a centralised controller system to a mobile device such a smartphone, tablet or PC, and also introduces energy monitoring and management functions.

REMOTE CONTROL AND ADJUSTMENT



INSTALLATION

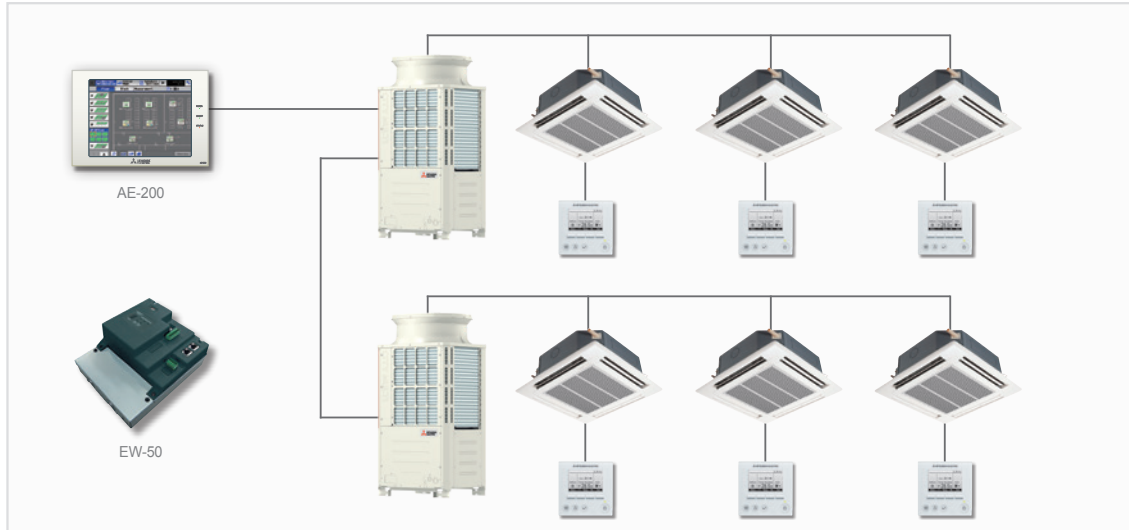

DATA COLLECTION



DATA ACQUISITION AND PROCESSING



External signal integration

The ability of a complex system to receive data from components and third party input signals allows for even more advanced management of the system itself. Integrating measurement signals for different parameters makes it possible to monitor and, therefore, manage the entire system more effectively and efficiently. For instance, variations in temperature may be monitored with a sensor while a consumption meter may be used to measure and bill energy consumption. These input signals may be used to optimise the functions of the system as a whole.



BMS integration

A building management system (BMS) is capable of managing the main technical installations in a building even if they are from different manufacturers.

For this to be possible, however, the installations must be equipped with interfaces that are compatible with the BMS system.

Using a system such as this means that all the technical installations in the building — e.g. lighting, lifts, security and safety systems, energy usage and, of course, air conditioning — may be controlled and managed in concert for maximum efficiency.

Another advantage of these systems is that they allow the installations in the building to interact and exchange information with one another over a single communication network, without requiring the installation of complex and costly electrical connections and wiring.

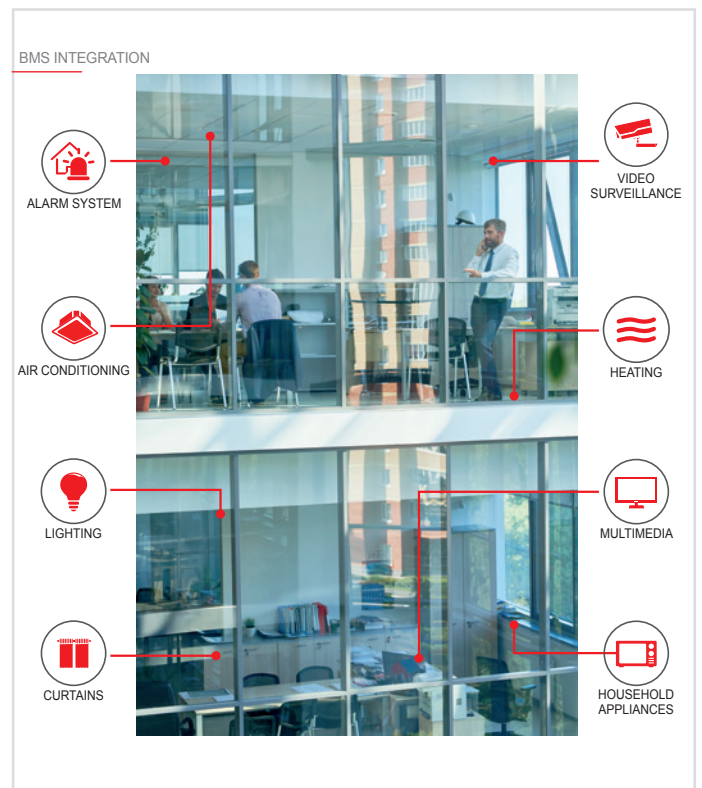



Standard UNI EN 15232

Standard UNI EN 15232 – Energy performance of buildings - Impact of Building Automation, Controls and Building Management. The European standard EN15232 defines the methods for evaluating the energy savings attainable in buildings in which automated management and control systems are used for technical installations and the electrical power system. The purpose of the standard is to define the impact of building automation on the energy performance of buildings, and applies to existing buildings, new building projects and reconstruction projects.

- Class D “NON ENERGY EFFICIENT”: this class includes all conventional installations without automation or control functions, which are not energy efficient;
- Class C “STANDARD”: installations with conventional building automation and control systems (BACS), which may be equipped with communication BUS networks but attain significantly less performance than they are effectively capable of;
- Class B “ADVANCED”: this class includes installations equipped with advanced building automation and control systems (BACS) which also feature certain technical building management (TBM) functions specifically for the centralised and coordinated management of the individual systems in the building;
- Class A “HIGH ENERGY PERFORMANCE”: high energy performance BAC and TBM systems; in other terms, systems with sufficient precision and with comprehensive automated control functions which ensure that the installation operates with the highest possible energy performance.

It is imperative that all electrical and technical installations, whether new or existing, and heating and air conditioning installations in particular, are equipped with adequate devices or systems for their control, adjustment and automation. The purpose of automation systems is to maximise the energy efficiency of the installations in the building in accordance with external ambient conditions and the variable usage and occupancy scenarios possible within the building itself, while also offering the highest possible levels of comfort, safety and quality. Managing the technological systems in a building saves energy, reduces CO₂ emissions and contributes to improving environmental performance in compliance with the most widely applied national and international directives.



for a greener tomorrow

Mitsubishi Electric solutions for attaining compliance with UNI EN 15232

Mitsubishi Electric offers state of the art solutions to meet today’s needs for greater energy efficiency. A choice of different types of control system is available to cater for differing needs which, in addition to responding in full to the requirements of the users, also contribute to reducing energy consumption in compliance with the European standard.

CLASS	DEFINITION	MITSUBISHI ELECTRIC SOLUTION
A	High energy performance BAC and TBM systems; in other terms, systems with sufficient precision and with comprehensive automated control functions which ensure that the installation operates with the highest possible energy performance	BMS integration, Climasync, AHC external signals, RMI
B	Installations equipped with advanced building automation and control systems (BACS) which also feature certain technical building management (TBM) functions specifically for the centralised and coordinated management of the individual systems in the building	AE-200/EW-50 centralised control systems, BMS Integration
C	Installations with conventional building automation and control systems (BACS), which may be equipped with communication BUS networks but attain significantly less performance than they are effectively capable of	M-Net network with ME and MA remote controllers
D	Conventional installations without automation or control functions, which are not energy efficient	MA remote controllers

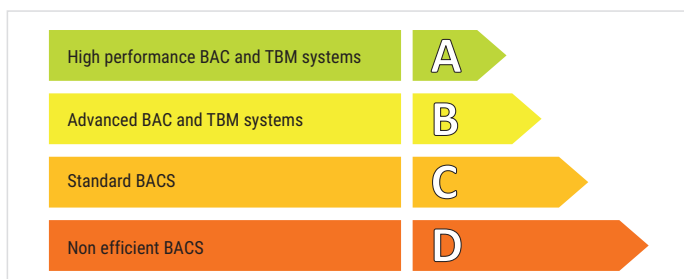





Glossary

M-Net

The Mitsubishi Electric control system uses a proprietary communication protocol denominated M-Net for communication between Mitsubishi Electric devices. The line between connected devices consists of a single, flexible and shielded 2-wire bus cable. M-Net may be interfaced with all open building management protocols (KNX, Modbus, LON, BACnet®).

M-Net address

All the devices connected to the M-Net data transmission bus are assigned a numerical identifier (address) from 0 to 255. Examples of M-Net devices (City Multi indoor units, ME etc.).

Group

A set of indoor devices controlled simultaneously. Blocks and floors consist of groups. The maximum number of units per group is 16.

Block

A block consists of multiple groups controlled simultaneously. The maximum number of groups per block is 50.

Floor

Floors may also be created, with each floor containing groups. The graphic user interface for floors is different from the interface used for blocks.

MA remote controller

The MA remote controller is a control panel which may be used to manage a group containing up to 16 indoor units. The remote controller must be connected to each of the indoor units in the group with a 2-wire non-polarised cable. This remote controller does not have an M-Net address.

Example wired remote controllers: PAC-YT52, PAR-41.

ME remote controller

The ME remote controller is a control panel which may be used to manage a group containing up to 16 indoor units. This remote controller is assigned an M-Net address. The M-Net addresses of the indoor units controlled by this device must be set on the controller itself.

The main advantage of this device over an MA remote controller is the ability to reconfigure the group by simply adding and/or removing the M-Net addresses of the indoor units without having to rewire the remotely controlled indoor units.

Example remote controller: PAR-U02.

Centralised control

To manage more than 16 units both collectively and individually from a single central point, or to allow access to advanced setting functions (e-mail notification messages), a centralised controller must be used. The control capabilities over the indoor units controlled depend on the type of controller used.

Example centralised control systems: AT-50, EW-50, AE-200.

Web server control (AE-200 and EW-50)

With this control solution, a web interface for monitoring and control functions may be accessed from a computer. To do this, the centralised remote controller is connected to a local network and the interface is accessed from the computer via its IP address.

IP address: each component in a data network is assigned a numerical identifier (address) consisting of 4 numbers from 0 to 255. In general, in a domestic local network, the IP addresses of the components in the network range from 192.168.1.0 to 192.168.1.255.

This interface is accessed from a web browser such as Internet Explorer, Google Chrome, Mozilla Firefox or Safari. The IP address of the remote controller must be entered in the browser in the form of a url link as follows: [https://\[IP address of the remote controller\]/it/administrator.html](https://[IP address of the remote controller]/it/administrator.html)

M-NET POWER **M-Net Power - Uninterrupted power supply system for VRF indoor units**

The exclusive M-Net Power system by Mitsubishi Electric ensures uninterrupted operation of the installation even in the event of power loss or partial malfunction of one or more indoor units.

Exclusive M-Net Power technology by Mitsubishi Electric is extraordinarily reliable and flexible: the M-Net data transmission line and separate power and control circuits ensure the uninterrupted operation of the indoor units of the entire air conditioning system.

Total flexibility in planning and laying out 230V AC power circuits, without the need for shared main lines and without requiring any additional devices to attain compliance with legislation for electrical systems, is a fundamental prerequisite for an air conditioning installation.

This circuit configuration is essential for situations where the system itself is shared by multiple owners or tenants, and where each must be able to electrically isolate their respective indoor terminal sections when required.

Furthermore, this system is also capable of identifying the following conditions automatically:

- indoor unit malfunction.
- power loss to indoor unit.

In the event of one of these conditions, the outdoor unit isolates the malfunctioning indoor unit or indoor unit receiving no power, to ensure the continued electrical and refrigeration functionality of the system with no action from a technician and/or a system administrator.

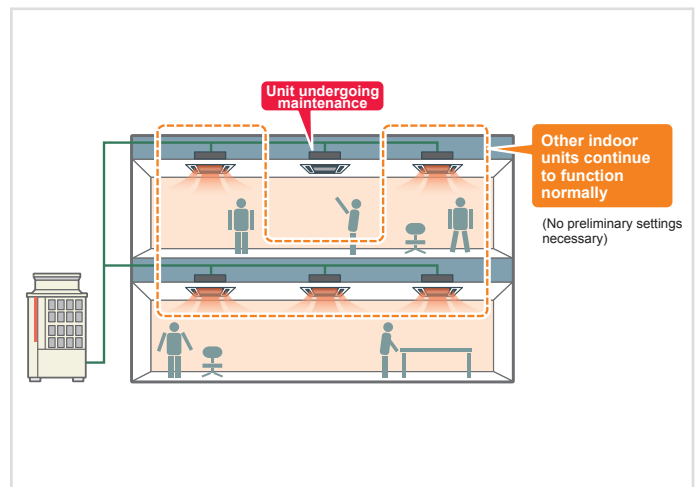
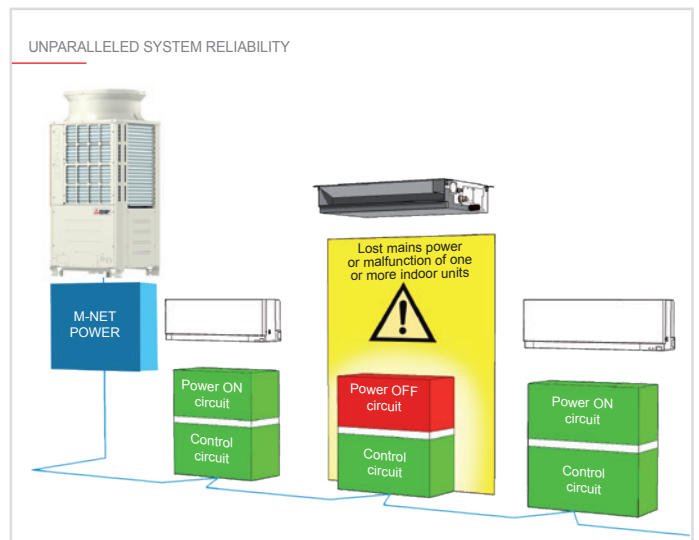

Controller types

MA remote controller

Mitsubishi Electric controller systems are primarily subdivided into MA controllers and ME controllers.

MA controllers use automatic addressing technology: when a

physical connection is made via the specific terminal board, the remote controller automatically assigns an address to the indoor unit or group* of indoor units to be managed.

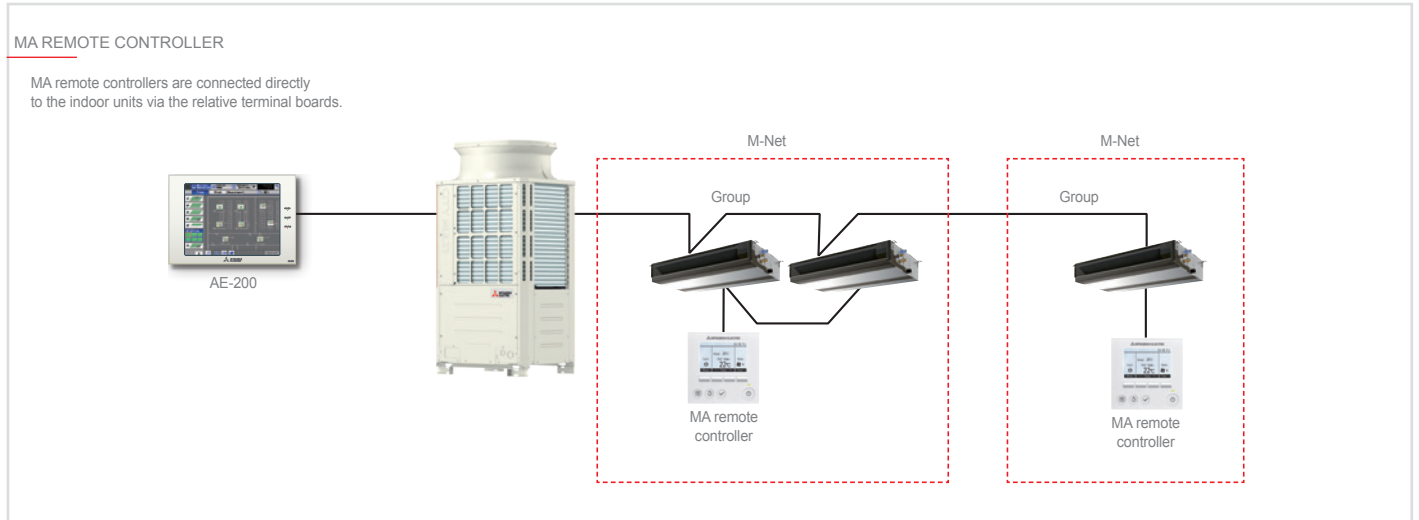

ME remote controller

ME controllers feature configurable address technology: when the connected to the M-Net data transmission network is made via the relative terminal board of the indoor unit to be controlled,

the remote control is associated with the indoor unit or group* of indoor units with logical addressing.



*A group is a set of up to 16 indoor units of the same type, which may be managed from a single remote controller

The concept of addressing

The exclusive M-NET data transmission system developed specifically by Mitsubishi Electric is used for data exchange between the devices in the installation.

This system allows for data transfer between the different devices over a single, shielded unpolarised cable with two core wires.

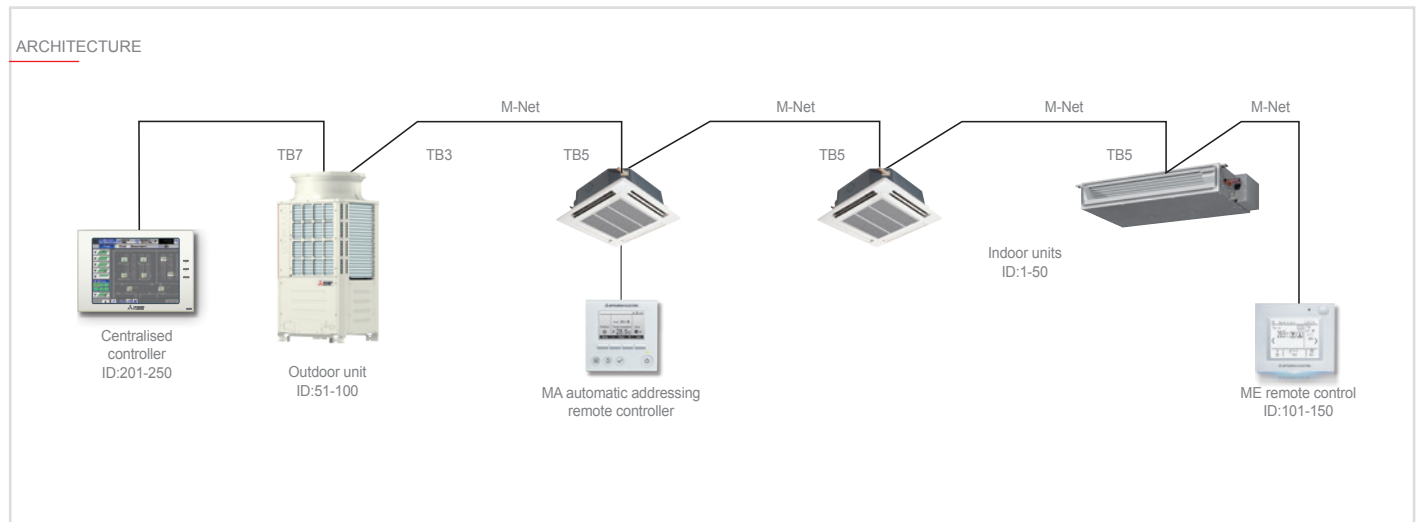

The concept of grouping

Indoor units of the same model may be organised in sets called 'groups' for operation in unison (for simultaneous selection of functions such as On/Off, mode, Set Point, fan speed etc.). All the indoor units must be of the same model to ensure that they all have identical functions.

According to the logic applied, the unit with the lowest M-Net address will be the "Master" for the relative group. Example:

Group 1 - Units 1, 2 and 3 = Unit 1 is the Master unit

Group 4 - Units 4, 5, 6 and 7 = Unit 4 is the Master unit

This is important for integration, as the BMS will address

signals to and from the Master unit only. Groups may in turn be organised into logical sets denominated 'blocks'. Blocks may be used for billing and apportioning energy consumption (User Blocks) or for managing other functions (e.g. timer programming). These blocks cannot be viewed or managed via the BMS, and are logical sets utilised solely for the purpose of centralised control.

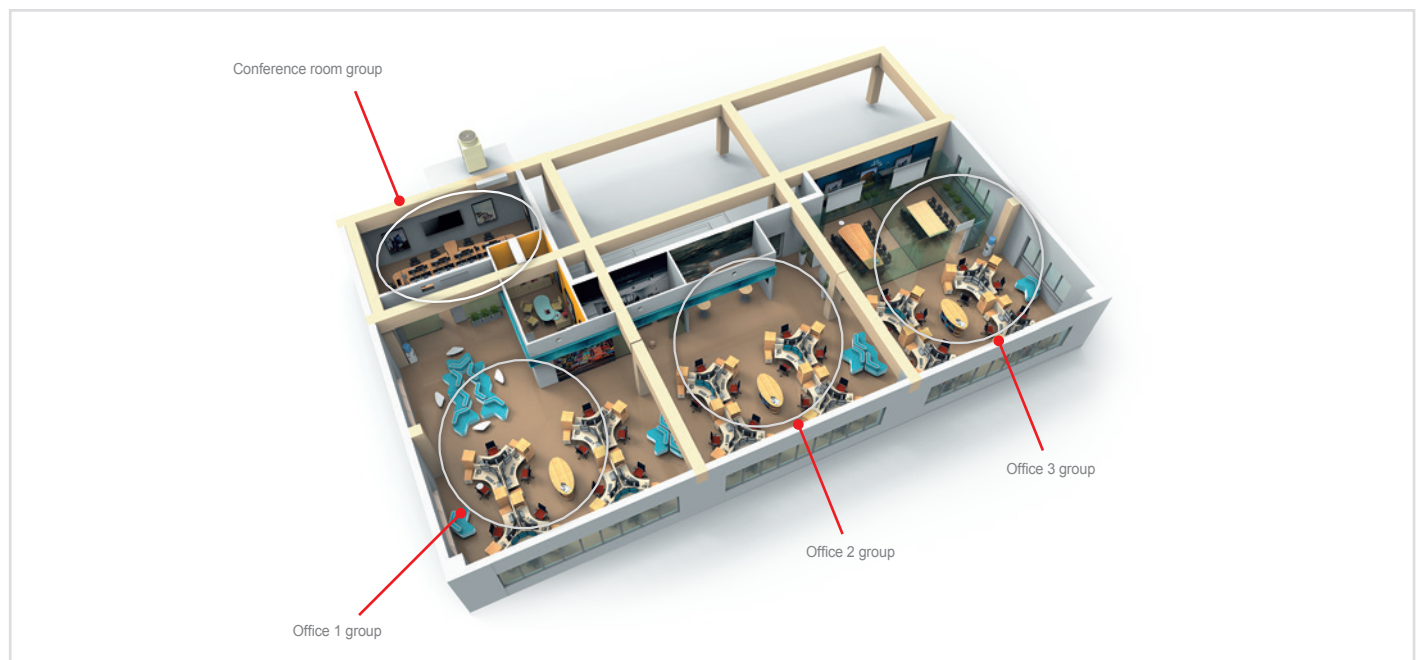



Key Technologies

Mitsubishi Electric applies innovation to develop new functions and technological solutions at the service of comfort and energy efficiency.

Functions



Night mode

This function further reduces the noise produced by the outdoor unit by reducing the maximum fan speed and compressor frequency in consideration of the reduced demand for thermal power during night time operation.



View and set setpoint temperatures in 0.5°C steps

To allow the user precise control for even greater comfort, setpoint temperatures are displayed and set in 0.5°C steps.



Daily schedule

The daily schedule programming function may be used to switch the unit on and off in accordance with the settings made by the user and is effective only for the current day. The schedule is cancelled automatically at midnight at the end of the day on which the schedule was programmed.



Weekly schedule

The weekly schedule programming function may be used to plan the operation and settings of the installation for a week. Up to 5 weekly schedules are settable.



Annual schedule

The annual schedule programming function lets the user define “special” days, during which the installation is required to operate with different settings than those defined for the current weekly schedule. Up to 52 special days may be set during the year.

Energy savings



Energy Management

The Energy Management function displays parameters relative to the energy management of the installation (energy consumption, operating times, external temperature etc.) in graph form.



Dual Setpoint

The new Dual Setpoint function makes it possible to preset setpoint temperatures for cooling and heating mode in a single operation.



Night Setback — Maintenance temperature

Heating (cooling) mode is activated when, after the monitored group has stopped, the temperature in the room drops below (rises above) the set lower (upper) limit.



Occupancy Sensor

The occupancy sensor detects if a room is vacant and enables automatic control of the indoor units to implement energy saving strategies (ON/OFF, fan speed etc.) based on the effective occupancy of each room.



Temperature and humidity sensor

The temperature setting is adjustable with a resolution of 0.5°C, while humidity may be monitored and controlled using external devices connected to the system via AHC.

Special functions



Light sensor

The light sensor measures the light levels in the conditioned room and adjusts the brightness of the remote control display accordingly.



LED

The LED status indicator indicates the status of active functions on the remote control. Each colour is associated with a status or function: The LED indicator may be temporarily or permanently disabled.



Touch

LCD Touch screen display.



Bluetooth®

Bluetooth® Low Energy connectivity lets users connect their smartphones or tablets to the remote controller.



Apps

Dedicated apps (User app and Professional app) permit control of the remote controller from a smartphone or tablet.



Custom home screen logo

A custom logo may be displayed in the menu home screen. The logo is displayed in the home screen whenever the display backlight is active.



Custom colour schemes

180 colour schemes (for the fonts and background) are available for the display.

Connection



M-Net Connection

ME M-Net addressing technology.



BACnet®

The installation can connect directly to a home automation system using the BACnet® protocol without interfaces.



AHC compatible

Compatible with AHC (Advanced HVAC Controller) programmable controller.



Web Server

The operating parameters of all the indoor units in the installation may be monitored and managed from any PC on the same local network (LAN or Wi-Fi network of controller) via a web browser.

Control systems

Remote Controllers

PAC-YT52CRA Design remote controller	24
PAR-41MAA Deluxe remote controller	26
PAR-CT01MA Prisma remote controller	28
PAR-U02MEDA Advanced remote controller	31
PAR-FL32 Wireless remote controller	34
PAR-SL101 Wireless remote controller for four-way cassette units	35
PAR-W21MAA Ecodan remote controllers	36
PZ-62DR-EB Lossnay / remote controller	38

Centralised controllers

AT-50B Centralised system control	50
WEB SERVER CENTRALISED CONTROLLERS	
AE-200E Web server centralised controller - 3D Touch Controller	56

EW-50E Web server centralised controller - 3D Blind Controller	60
---	----

PIN CODE LICENSES FOR CENTRALISED CONTROLLERS

3D CHARGE Consumption apportioning system for centralised controllers	64
--	----

3D PLAN Installation layout map display system for centralised controllers	65
---	----

Remote management and supervisor systems for VRF and HVRF installations

3D TABLET CONTROLLER Wi-Fi management systems	68
--	----

MELCLOUD CITY MULTI

Cloud-based remote management and supervisor system	70
---	----

REMOTE MONITOR INTERFACE (RMI) Cloud-based remote

management and supervisor system for professional use	72
---	----



External signal integration

M-NET-AHC-24VDC AHC programmable controller	81
PAC-YG60MCA M-Net interface for digital impulse consumption meters	82
PAC-YG63MCA M-Net interface for analogue sensors	83
PAC-YG66MCA M-Net interface for digital sensors	84
SMART TERMINAL BLOCKS	
PAC-SC36NA External signal adapter for outdoor units	87
PAC-SC37SA-E External signal adapter for outdoor units	88
PAC-SE55RA External signal adapter for indoor units	88
PAC-SA88HA External signal adapter for indoor units	89

BMS integration

XML Ethernet based BMS integration	91
LMAP04 BMS for LonWorks® networks	92
PINCODE BMS integration for BACnet® networks	94
ME-AC-MBS-100 BMS interface for Modbus® networks	96
ME-AC-KNX-100 BMS interface for KNX® networks	98

CLIMASYNC centralised control, adjustment and synchronisation system

CLIMASYNC	100
------------------	-----



Control systems



PAC-YT52CRA

DESIGN REMOTE CONTROLLER



PAR-41MAA NEW

DELUXE REMOTE CONTROLLER



PAR-CT01MA

PRISMA REMOTE CONTROLLER



PAR-U02MEDA

ADVANCED REMOTE CONTROLLER



PAR-FL32MA PAR-SL101A-E

WIRELESS REMOTE CONTROLLER



PAR-W21MAA

ECODAN REMOTE CONTROLLERS



PZ-62DR-EB NEW

LOSSNAY REMOTE CONTROLLER



AT-50B

CENTRALISED SYSTEM CONTROLLER



AE-200E

3D TOUCH Controller
WEB SERVER CENTRALISED CONTROLLER



EW-50E

3D BLIND Controller
WEB SERVER CENTRALISED CONTROLLER



3D TABLET CONTROLLER

WI-FI REMOTE MANAGEMENT SYSTEM



MELCloud CITY MULTI

CLOUD-BASED REMOTE MANAGEMENT AND SUPERVISOR SYSTEM



RMI

Remote Monitoring Interface
CLOUD-BASED ENERGY CONSUMPTION MONITORING SYSTEM



M-NET-AHC-24VDC

AHC PROGRAMMABLE CONTROLLER (ADVANCED HVAC CONTROLLER)



EXTERNAL SIGNAL INTERFACES

EXTERNAL SIGNAL INTEGRATION



BMS INTERFACES

BMS INTEGRATION



CLIMASYNC

CENTRALISED CONTROL, ADJUSTMENT AND SYNCHRONISATION SYSTEM



Remote controls

	PAR-SL101	PAR-FL32	PAC-YT52	PAR-41	PAR-CT	PAR-U02
Remote control functions						
Function						
Number of groups/IUs controllable	1/1	1/16	1/16	1/16	1/16	1/16
ON/OFF	•	•	•	•	•	•
Set Heat/Cool modes	•	•	•	•	•	•
Temperature setting	•	•	•	•	•	•
Dual Set-point *1	•*2		•	•	•	•
Fan speed	•	•	•	•	•	•
Air flow direction	•	•	•	•	•	•
Backlight	•		•	•	•	•
View error code			•	•	•	•
Daily timer				•	•	•
Weekly timer				•	•	•
AUTO-OFF				•	•	•
Temp-set restrictions			•	•	•	•
Temperature sensor			•	•	•	•
Night Setback				•	•	•
Bluetooth®					•	
Customisable display and logo					•	
LED colour						•
Humidity sensor						•
Occupancy Sensor						•
Light sensor						•
Connection	Infra-red	Infra-red	TB15 terminal board	TB15 terminal board	TB15 terminal board	TB5 terminal board

*1 Only available in all indoor units, remote controls and system controllers associated with group have this function. *2 specific setting required to enable function for this remote control.

Key Technologies

Energy savings



Dual Setpoint

The new Dual Setpoint function makes it possible to preset setpoint temperatures for cooling and heating mode in a single operation. On Y series heat pump models, this functions means that it is no longer necessary to reset setpoint temperatures each time the operating mode of the unit is switched from Heating to Cooling mode and vice versa. In R2 heat recovery systems, it is also possible for set an “energy saving” temperature band for AUTO mode, within which the system ventilates only and performs no thermal air treatment (thermo off). Setting a broader band increases energy savings, but permits larger temperature variations in the indoor space. Setting the two setpoint temperatures closer together creates a narrower thermo off band, prioritising maximum comfort in the indoor space over energy savings.

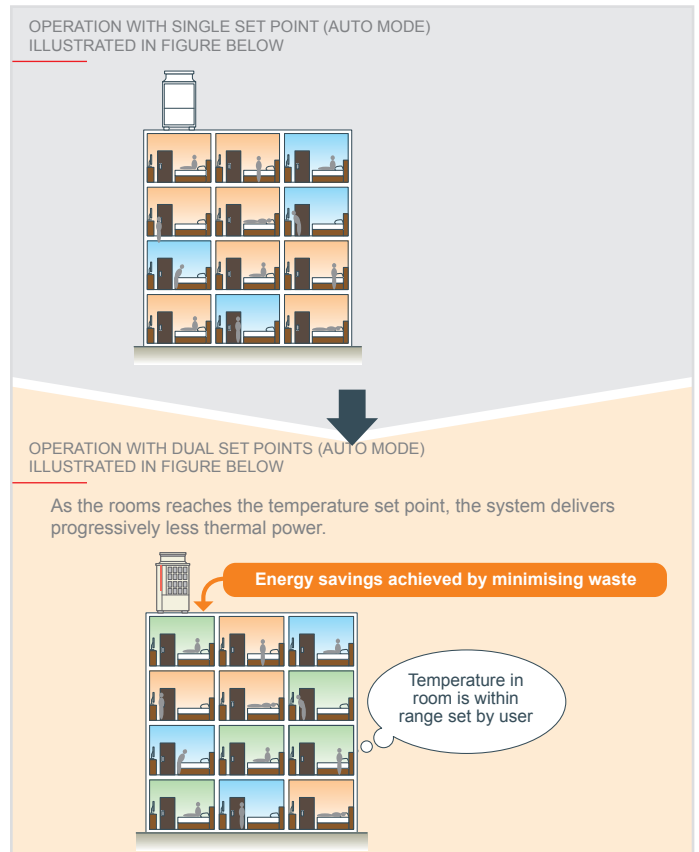
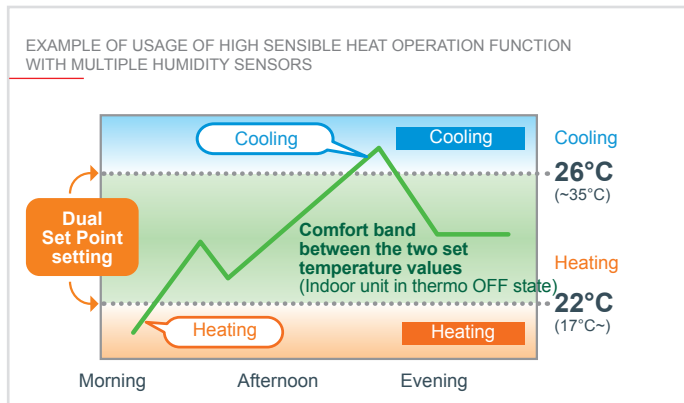

Heating mode Heating mode Thermo OFF





Night Setback - Maintenance temperature

The Night Setback - Maintenance temperature function activates heating mode when, after the monitored group has stopped, the temperature in the room drops below the set lower limit. The function also activates cooling mode when, after the monitored group has stopped, the temperature in the room rises above the set upper limit. This function is not available if the operating mode and temperature setting are modified from the remote control.

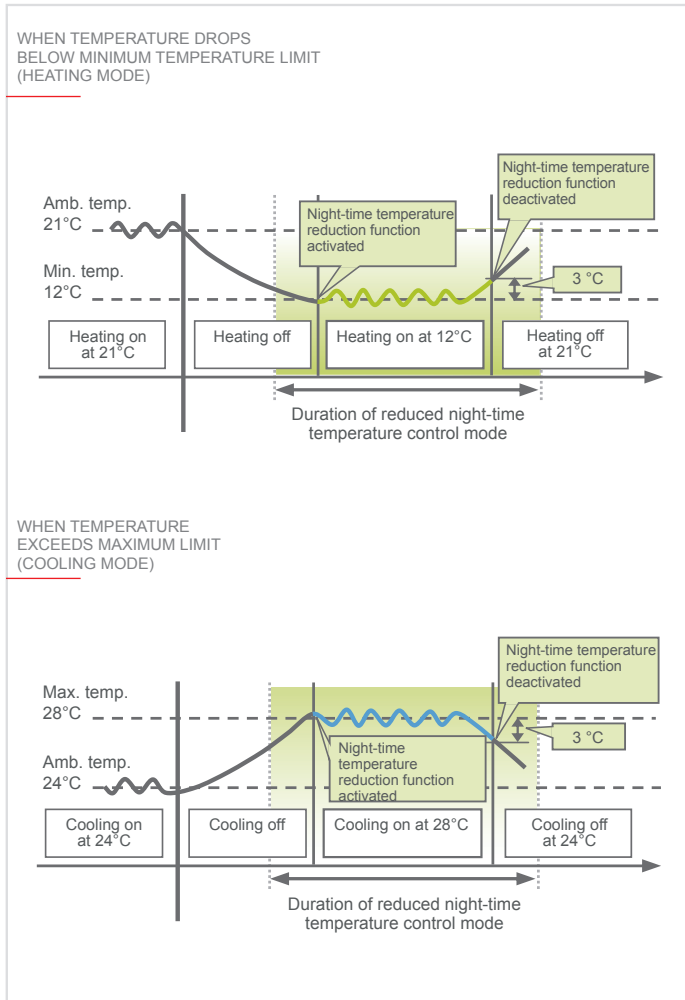

i If the ambient temperature is measured in the same position as the indoor unit air intake, the temperature reading will not be precise when the unit is inactive. In this case, install a remote sensor (PAC-SE41TS-E) or use the built-in sensor of the remote control to move the temperature acquisition point.

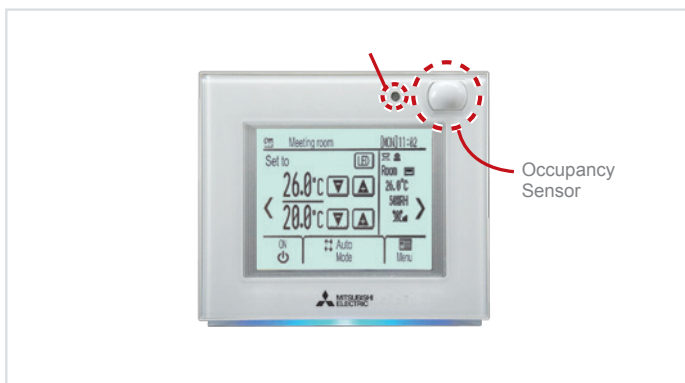

Occupancy Sensor

The occupancy sensor detects if a room is vacant and enables automatic control of the indoor units to implement energy saving strategies based on the effective occupancy of each room. The occupancy sensor enables the following energy saving functions:

- Switch indoor units ON/OFF based on occupied/vacant state of room;
- Fan speed control;
- Switch indoor unit from Thermo ON to Thermo OFF state;
- Configure temperature deviation based on occupied/vacant status.

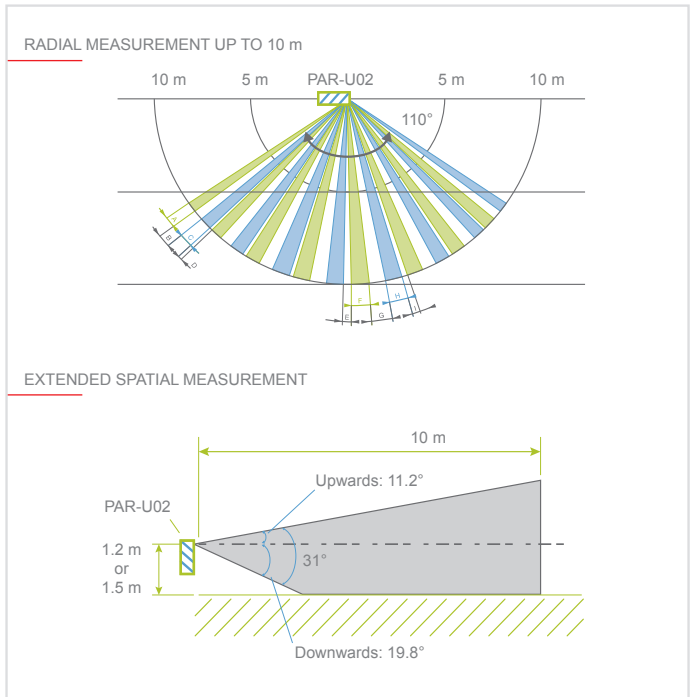

Special functions



Light sensor

The light sensor measures the light levels in the conditioned room and adjusts the brightness of the remote control display accordingly. Bright/dark thresholds may be set directly from the remote control over an extended luminosity range (1 to 65535 lx). The light sensor is also used in low light conditions to confirm the occupied/vacant status of the room.

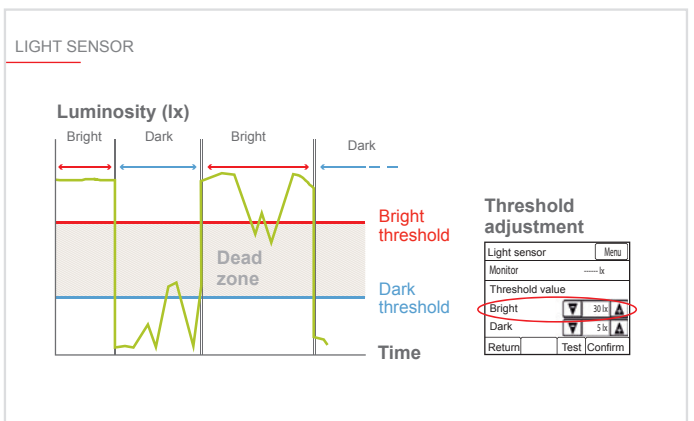



Functions



View and set setpoint temperatures in 0.5°C steps

The goal of Mitsubishi Electric is to offer a better quality of life through innovative products. Mitsubishi Electric was the first manufacturer to introduce the capability of viewing and setting setpoint temperatures in 0.5°C increments, for unparalleled comfort calibrated with decimal precision by the user. This function gives the user a greater sense of control and, therefore, comfort, by offering a wider and more precise choice of settable temperatures.

indicatore di stato
LED

LED status indicator

The LED status indicator indicates the status of active functions on the remote control. Each colour is associated with a status or function: e.g. Red=Heating, Blue=Cooling, Flashing red=Error. The LED indicator may be temporarily or permanently disabled.

Broad operating temperature range

Extended comfort: the new extended temperature range function allows systems supporting the function to be set with maximum set points up to 35°C in cooling mode, and minimum set points as low as 4.5°C in heating mode.

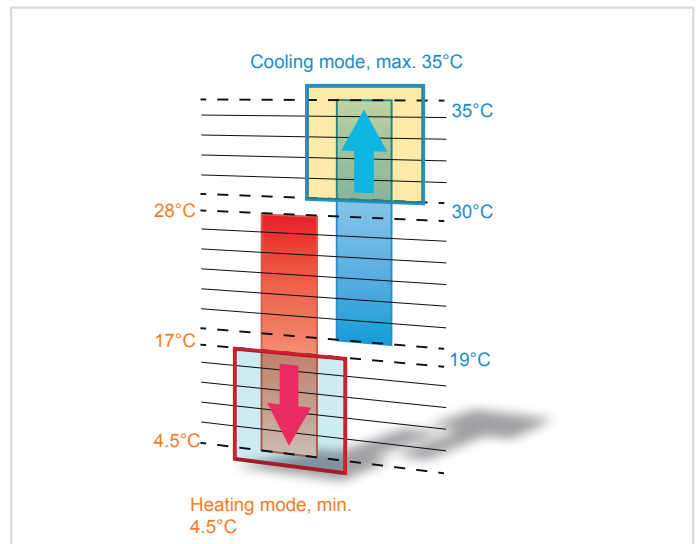

Defining settable temperature range

The setpoint range may be defined for the remote controls to limit the range of temperatures settable by users. This avoids waste, preventing individual units from being operated with non-optimal settings made erroneously in response to the subjective perception of the ambient temperature, while still ensuring adequate environmental comfort.

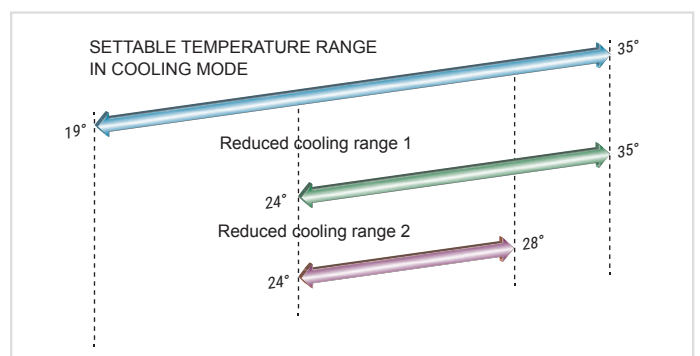

PAC-YT52CRA

DESIGN REMOTE CONTROLLER

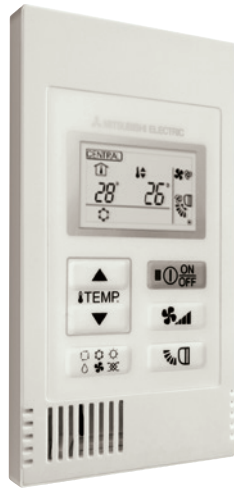

PAC-YT52CRA Design remote controller

- Display with white backlighting.
- Simple wall-mounted installation.
- Easy and intuitive with icon-based interface.
- Operating mode selection function.
- Swing louvre position selection function (for compatible indoor units).
- Usable to manage 1 group of up to 16 indoor units.
- Simple connection with single non-polarised two-core wire.
- MA automatic addressing technology.

- Suitable for all types of indoor unit.
- Recommended for hotels and public spaces, as ambient air temperature display can be disabled.
- Integrated temperature sensor usable instead of indoor unit sensor.
- Configurable temperature range settable from local keypad.

Technical specifications

MODEL	DIMENSIONS (L X H X W)	WEIGHT	ELECTRIC POWER SUPPLY	M-NET UNIT POWER CONSUMPTION
PAC-YT52	70 x 120 x 14.5 mm	100 g	12 VDC (supplied by indoor units)	0.3 W

ARCHITECTURE

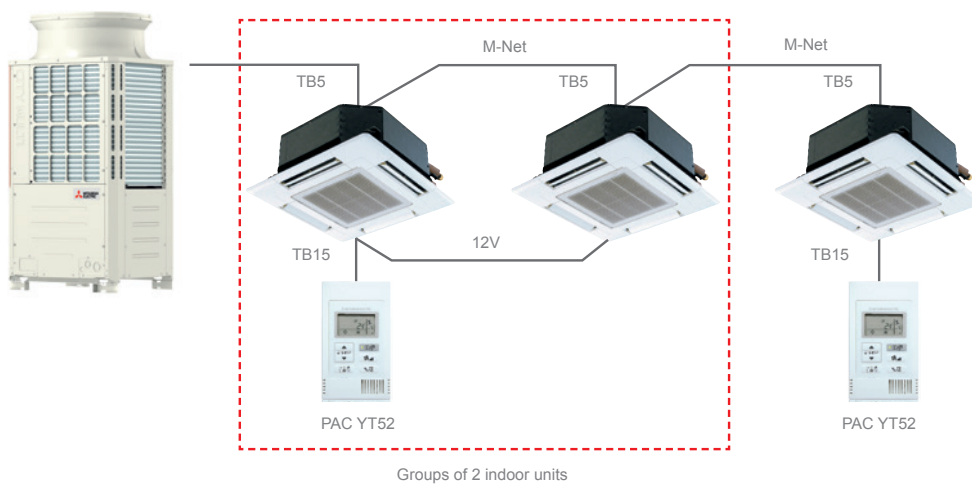



Key Technologies

								
--	--	--	--	--	--	--	--	--

FUNCTION	DESCRIPTION	SETTING	DISPLAY
ON/OFF	Switch between ON and OFF	○	○
Operating mode	For switching between cooling/dehum./fan/auto/heating modes Auto mode is only selectable if the indoor unit effectively offers this mode.	○	○
Temperature setting	Modify set temperature. The settable temperature range varies depending on the model of indoor unit.	○	○
Fan speed	Changes fan speed. Fan speeds available vary depending on the model of indoor unit installed.	○	○
Enable/disable local operations	The following functions may be disabled from specific settings on the centralised controller: ON/OFF, select operating mode, set temperature. The relative icon is shown on the display when a function is disabled.	×	○
Error	Displays error with relative unit address. An error code may not be displayed for certain errors.	×	□
Ventilation	For interlocked operation with CITY MULTI indoor units and Mr. SLIM indoor units with LOSSNAY unit.	○	○
Temperature range restrictions	Different settable temperature ranges may be defined for different operating modes.	○	○

○ Each group □ Each unit × Not available

PAR-41MAA NEW

DELUXE REMOTE CONTROL UNIT

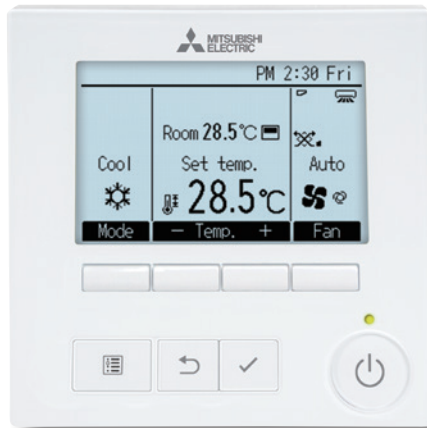

PAR-41MAA Deluxe remote control unit

- Display with white (factory setting) or black backlighting and adjustable contrast.
- Simple wall-mounted installation.
- Night Set-back function for setting minimum winter temperature or maximum summer temperature in temperature maintenance mode.
- Effective static overpressure selection function for ducted indoor units (PEFY-P VMHS only).
- Internal weekly timer function and simplified internal timers (Auto-off, etc.).
- Usable to manage 1 group of up to 16 indoor units.
- Easy and intuitive, with icon based graphic interface, direct control buttons and function buttons.
- Simple connection with single non-polarised two-core wire.
- **MA** self-addressing technology.

- Suitable for all types of indoor unit, including GUF.
- Integrated temperature sensor usable instead of indoor unit sensor.
- Configurable temperature range settable from local keypad.
- **View and set setpoint temperatures in 0.5°C increments.**
- Supports 3D i-see sensor functions
- **14 languages available** (English, French, Spanish, German, Italian, Dutch, Portuguese, Greek, Russian, Czech, Turkish, Polish, Hungarian, Swedish).
- Draft reduction *
"Close" has been added to the manual vane angle selection. The air outlet can be closed to reduce drafts from the air conditioner.

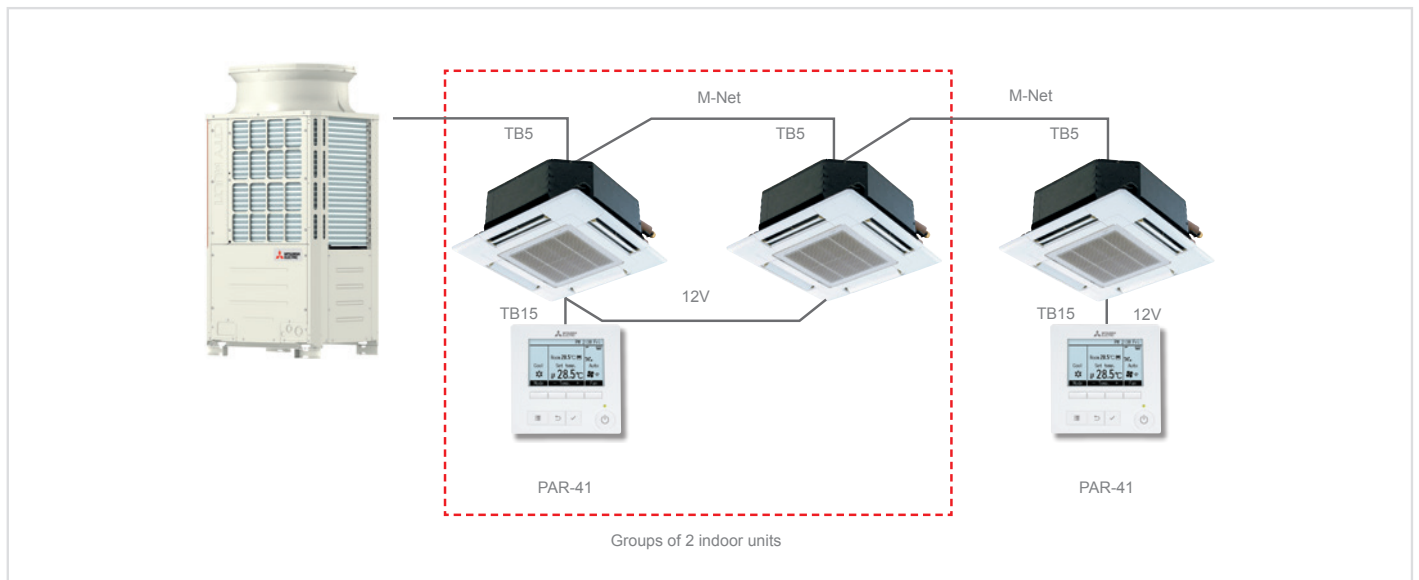

Key Technologies

--	--	--	--	--	--	--	--	--

ITEM	DESCRIPTION	SETTING	DISPLAY
ON/OFF	Switches between ON and OFF.	○	○
Operation mode switching	Switches between Cool/Dry/Fan/Auto/Heat.	○	○
Temperature setting	Changes the set temperature. * Set temperature range varies depending on the indoor unit model.	○	○
Fan speed setting	Changes fan speed. * Available fan speeds vary depending on the model.	○	○
Vane setting	Changes vane. * Available vanes vary depending on the model.	○	○
Louver setting	Switches between louver ON/OFF.	○	○
Ventilation equipment control	Interlocked setting and interlocked operation setting with City Multi Lossnay units can be performed. The Stop/Low/High settings of the ventilation equipment can be controlled.	○	○
Auto descending panel	Raises and lowers the automatic elevating panel.	○	×
Main display mode setting	The Main display can be displayed in two different modes: "Full" and "Basic."	○	○
B&W inversion	The colors of the display can be inverted, turning white background to black and black characters to white.	○	○
Clock	Date (year/month/day) and time (hour/minute) can be set. The set time as well as the day of the week will be displayed on the Main display. It is also possible to set not to display the time on the Main display. The clock can be displayed in 12-hour format (AM/PM before or after the time) and 24-hour format.	○	○
Daylight saving time	The start/end time for daylight saving time can be set. The daylight saving time function will be activated based on the setting contents.	○	×
Room temp. display	The room temperature display can be enabled or disabled.	—	○
Error information	When an error occurs, an error code and the unit address appear. The air-conditioning unit model, serial number, and contact number can be set to appear when an error occurs. (The above information needs to be entered in advance.) * An error code may not appear depending on the error.	—	○
Filter information	A filter sign will appear when it is time to clean the filter.	—	○
Remote controller information	The version of the remote controller can be checked.	—	○
Timer	ON/OFF timer. Turns ON and OFF daily at a set time. • Time can be set in 5-minute increments. • It is also possible to set the ON time only or the OFF time only. Auto-OFF timer. Turns off the unit after a certain period of operation. • Operation time can be set to a value from 30 to 240 minutes in 10-minute increments.	○	○
Weekly timer	Weekly ON/OFF times and set temperatures can be set. • Time can be set in 5-minute increments. Up to 8 schedule patterns can be set per day of the week. * Not valid when the ON/OFF timer is set.	○	○
Night Set-back	The temperature range and the start/stop times can be set.	○	○
Allows/disallows local operation	The following operation can be prohibited by applying certain settings on the centralized controller: ON/OFF, operation mode, set temperature, filter sign reset, vane, fan speed and timer. * While an operation is prohibited, the operation icon lights up (only on the Main display in the "Full" mode).	×	○
Operation lock	The following operations can be prohibited: "Location," "On/Off," "Mode," "Set temp.," "Menu," "Fan," "Louver," or "Vane."	○	○
Temperature range restriction	The room temperature range for each operation mode can be restricted.	○	○
Auto return	The units operate at the preset temperature after a designated period. (Time can be set to a value from 30 to 120 minutes in 10-minute increments.) * Not valid when the temperature setting range is restricted.	○	×
Password	Administrator password (required for schedule setting etc.) and Maintenance password (required for test run and function setting etc.) can be set.	○	×
Language Selection	Select the display language from the following 14 languages. English, French, Spanish, German, Italian, Dutch, Portuguese, Greek, Russian, Turkish, Czech, Hungarian, Polish, Swedish	○	○
Brightness Contrast	The brightness of the LCD can be adjusted. The contrast of the LCD can be adjusted.	○	○
Manual vane Angle	Fixes the vane position for each air outlet.	○	×
Service	Contains Test run, Function setting, Request code, and Error history.	○	○
3D i-See sensor	Settings for 3D i-See sensor can be made.	○	○

○ Ogni gruppo × Non disponibile — Non applicabile

PAR-CT01MA

PRISMA REMOTE CONTROLLER



PAR-CT01MAA-SB



PAR-CT01MAA-PB

PAR-CT01MA PRISMA remote controller

- Backlit colour touch screen display with adjustable contrast.
- Up to 180 user selectable colour schemes for fonts and background on display.
- Custom home screen logo
- Simple wall-mounted installation.
- Night Set-back function for setting minimum winter temperature or maximum summer temperature in temperature maintenance mode.
- Effective static overpressure selection function for ducted indoor units (PEFY-P VMHS only).
- Internal weekly timer function and simplified internal timers (Auto-off, etc.).
- Usable to manage 1 group of up to 16 indoor units.
- Easy and intuitive, with icon based graphic interface, direct control buttons and function buttons.
- MA automatic addressing technology.
- View and set setpoint temperatures in 0.5°C steps.
- Support for 3D i-see Sensor functions for 60x60 PLFY-P VFM-E1 4-way cassette unit and for 90x90 PLFY-P VEM-E 4-way cassette unit.

Custom colour schemes

180 USER-SELECTABLE COLOUR SCHEMES FOR FONTS AND BACKGROUND

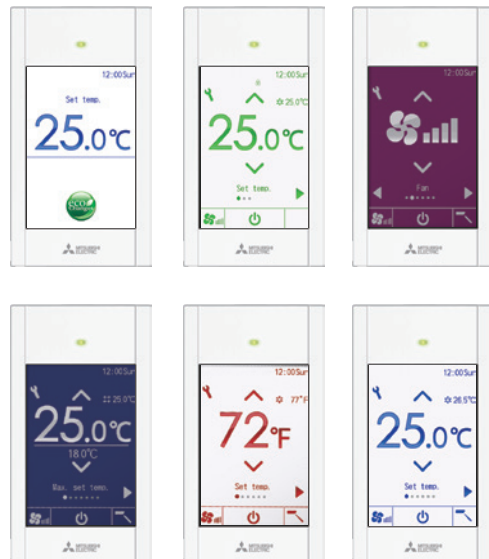

Technical specifications

MODEL	DIMENSIONS (L X H X W)	WEIGHT	ELECTRIC POWER SUPPLY	M-NET UNIT POWER CONSUMPTION
PAR-CT01	65 x 120 x 14.1 mm	100 g	12 VDC (supplied by indoor units)	0.3 W

Multi-language menu

14 selectable languages: English, French, Spanish, Italian, Portuguese, Greek, Turkish, Swedish, German, Russian, Czech, Hungarian, Polish

Large backlit colour touch screen display

The new PRISMA remote controller is equipped with a 3.5" HVGA colour touch screen display.



Display customisation functions

The user can customise the display simply to show only selected parameters.

Hotel function

The "Hotel" function may be used to set a simplified user interface extremely easily, to allow users to only view and modify certain parameters and functions such as ON/OFF, set point temperature and fan speed.

Bluetooth® connection

The PAR-CT01MA remote controller features Bluetooth® Low Energy connectivity. Two dedicated apps (User app and Professional app) may be used to connect your smartphone or tablet to the remote controller.

The User app lets you access the functions of the remote control (and, therefore, control the air conditioning system) from your smartphone or tablet as if you were using the remote control itself. The Professional app, on the other hand, simplifies the configuration of the remote controller during installation and commissioning of the system. This dedicated app lets you define and save settings on your mobile device and then transfer these settings quickly and easily to all the remote controller units in the installation, making the configuration process for the system significantly quicker and simpler.

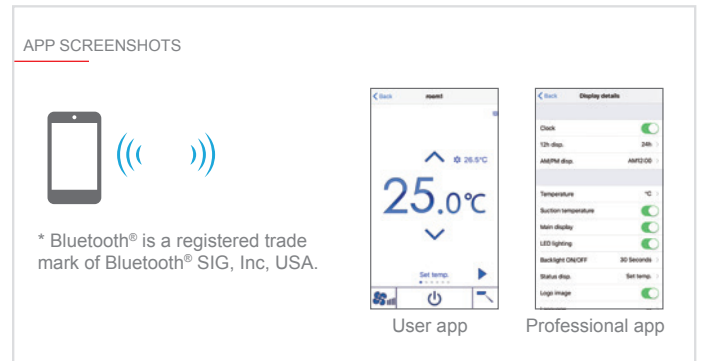

Logo image customization

A custom logo may be displayed in the menu home screen. The logo is displayed in the home screen whenever the display backlight is active. The display backlight function may be timer controlled or kept permanently on.

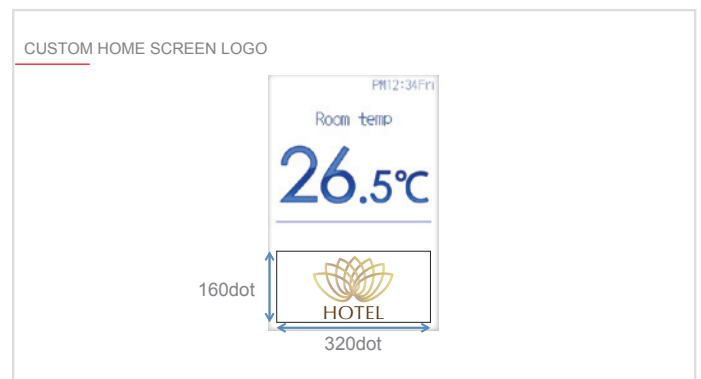

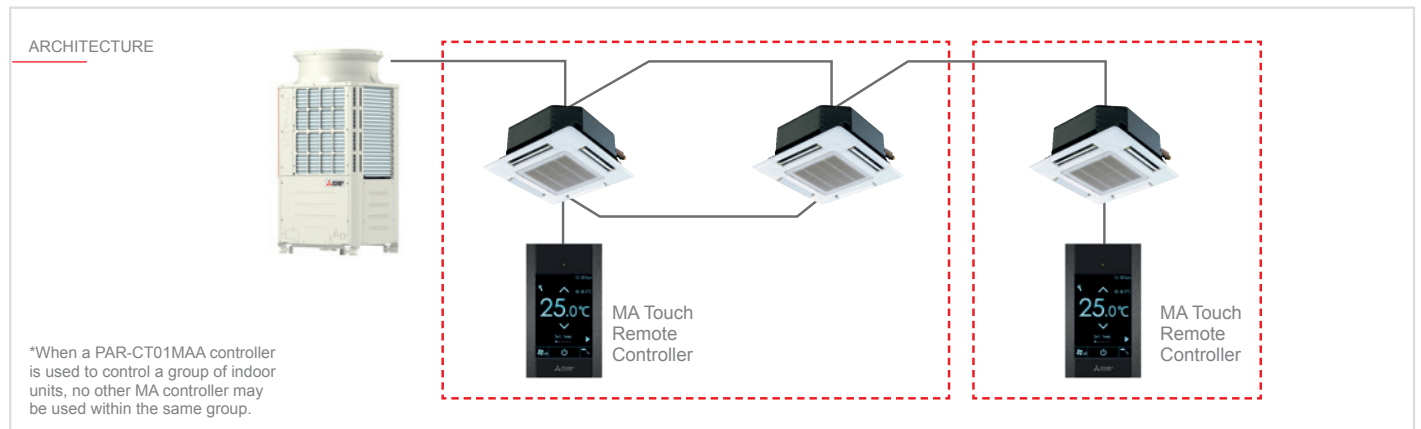

Key Technologies



FUNCTION	DESCRIPTION	SETTING	DISPLAY
ON/OFF	Switch between ON and OFF	○	○
Operating mode	For switching between cooling/dehum./fan/auto/heating modes Auto mode is only selectable if the indoor unit effectively offers this mode.	○	○
Temperature setting	Modify set temperature. The settable temperature range varies depending on the model of indoor unit.	○	○
Air flow direction	Modify direction of air flow. Selectable air flow directions depend on the model of indoor unit.	○	○
Swing louvre settings	Switch between swing louvre ON and OFF modes	○	○
Ventilation	Enables interlocked operation with CITY MULTI Lossnay units.	○	○
Error	Displays error with relative unit address. The following information may be displayed in the event of an error: indoor unit model, serial number, contact information (e.g. phone number of dealer). An error code may not be displayed for certain errors.	—	○
Timer	Used to set ON and OFF times. • Time settable in 5 minute steps. • Both ON and OFF times are settable. • Auto-OFF timer: Used to set Auto-Off time. • Time may be set within a range from 30 to 240 minutes in steps of 10 minutes.	○	○
Enable/disable local operations	The following functions may be disabled from specific settings on the centralised controller: ON/OFF, select operating mode, set temperature, fan speed, air flow direction, reset filter indicator lamp. The relative icon is shown on the display when a function is disabled.	×	○
Prohibited operations	May be used to disable the following functions: "Ambient", "On/Off", "Mode", "Set Temp.", "Menu", "Vent", "Louvre" or "Defl.".	○	○
Temperature range restrictions	Different settable temperature ranges may be defined for different operating modes.	○	○
Auto return	Used to force the units to operate at a preset temperature after operating for the specified period of time (time may be set within a range from 30 to 120 minutes in steps of 10 minutes). This function is not available if preset temperature ranges are limited.	○	×
Set speed	Modifies fan speed. The speeds available vary depending on the model of indoor unit installed.	○	○
Auto grille down	Automatically raises or lowers panel.	○	○
Daylight saving time	Set the daylight saving time. This function is activated in accordance with settings.	○	○
Weekly timer	Used to set weekly ON and OFF times. Time is settable in 5 minute steps. Up to eight operating patterns are available per day. Not available when Timer ON/OFF mode is active.	○	○
Night Set-back	Temperature ranges and start/end times are settable for mode.	○	○
Bluetooth®	The remote controller may be controlled from a smartphone or tablet via Bluetooth® with a dedicate app. The dedicated app may be used to send custom logos or settings to the remote control.	○	○
Remote controller information	For checking version of remote controller.	—	○

○ Each group × Not available

PAR-U02MEDA

ADVANCED REMOTE CONTROLLER



PAR-U02MEDA Advanced remote controller

The Mitsubishi Electric Advanced remote control may be used to control up to 16 indoor units. While advanced, this controller also offers essential functions such as monitoring and controlling the status of the units in the system, and a weekly/hourly timer. Four integrated sensors (temperature, humidity, occupancy and light) allow a series of advanced adjustment and control functions. For example, the occupancy sensor can be used to save energy by configuring different modes based on the occupied/vacant status of each room.

- Large monochrome LCD touch screen display with white backlighting.
- Usable to manage 1 group of up to 16 indoor units.
- Integrated temperature, humidity, occupancy and light sensors.
- SMART energy saving and comfort functions.

- Contextual colour LED indicating operating status of indoor units.
- View and set setpoint temperatures in 0.5°C steps.
- Dual Setpoint function
- Internal weekly timer, daily timer and simplified timer (Auto-off, etc.) functions.
- ME M-Net addressing technology.
- Extended setting ranges for setpoints (Cool: 19-35°C; Heat: 5-28°C).
- New functions for use in conjunction with AHC Programmable Controller (PLC M-Net), for creating operating strategies with generic devices

Technical specifications

MODEL	DIMENSIONS (L X H X W)	WEIGHT	ELECTRIC POWER SUPPLY	M-NET UNIT POWER CONSUMPTION
PAR-U02	140 x 120 x 25 mm	300 g	17-32 VDC (M-Net connection)	0.5 M-Net unit

ARCHITECTURE

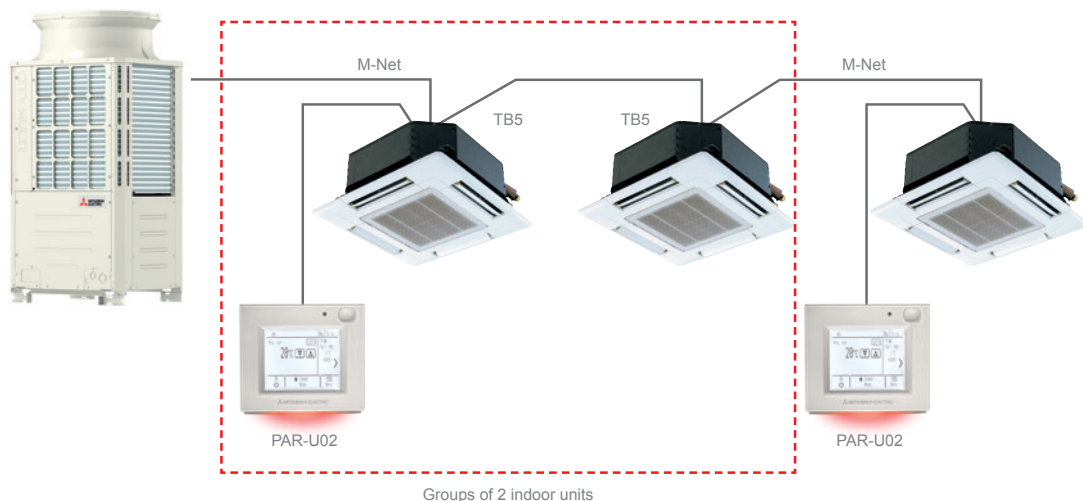

Groups of 2 indoor units

Temperature and humidity sensor

The integrated temperature and humidity sensor may be used to increase perceived comfort levels, while the ability to adjust the temperature with a precision of 0.5°C gives the user an even greater sense of control. The relative humidity sensor, combined with the ability to interlock the remote control with a programmable AHC controller, makes it possible to control humidity with external devices connected to the system via the AHC.

Light sensor

The light sensor measures the light levels in the conditioned room and adjusts the brightness of the remote control display accordingly. Bright/dark thresholds may be set directly from the remote control over an extended luminosity range (1 to 65535 lx). The light sensor is also used in low light conditions to confirm the occupied/vacant status of the room.

Application 1: Splitting existing indoor spaces

The need

- An existing indoor space is split into two spaces served by two indoor units each.

Solution

- The ME controller may be used to control the two spaces separately by adding a remote controller and reassigning the addresses of the two indoor units.

Occupancy Sensor

The occupancy sensor detects if a room is vacant and enables automatic control of the indoor units to implement energy saving strategies based on the effective occupancy of each room. The occupancy sensor enables the following energy saving functions:

- Switch indoor units ON/OFF based on occupied/vacant state of room;
- Fan speed control;
- Switch indoor unit from Thermo ON to Thermo OFF state;
- Configure temperature deviation based on occupied/vacant status.

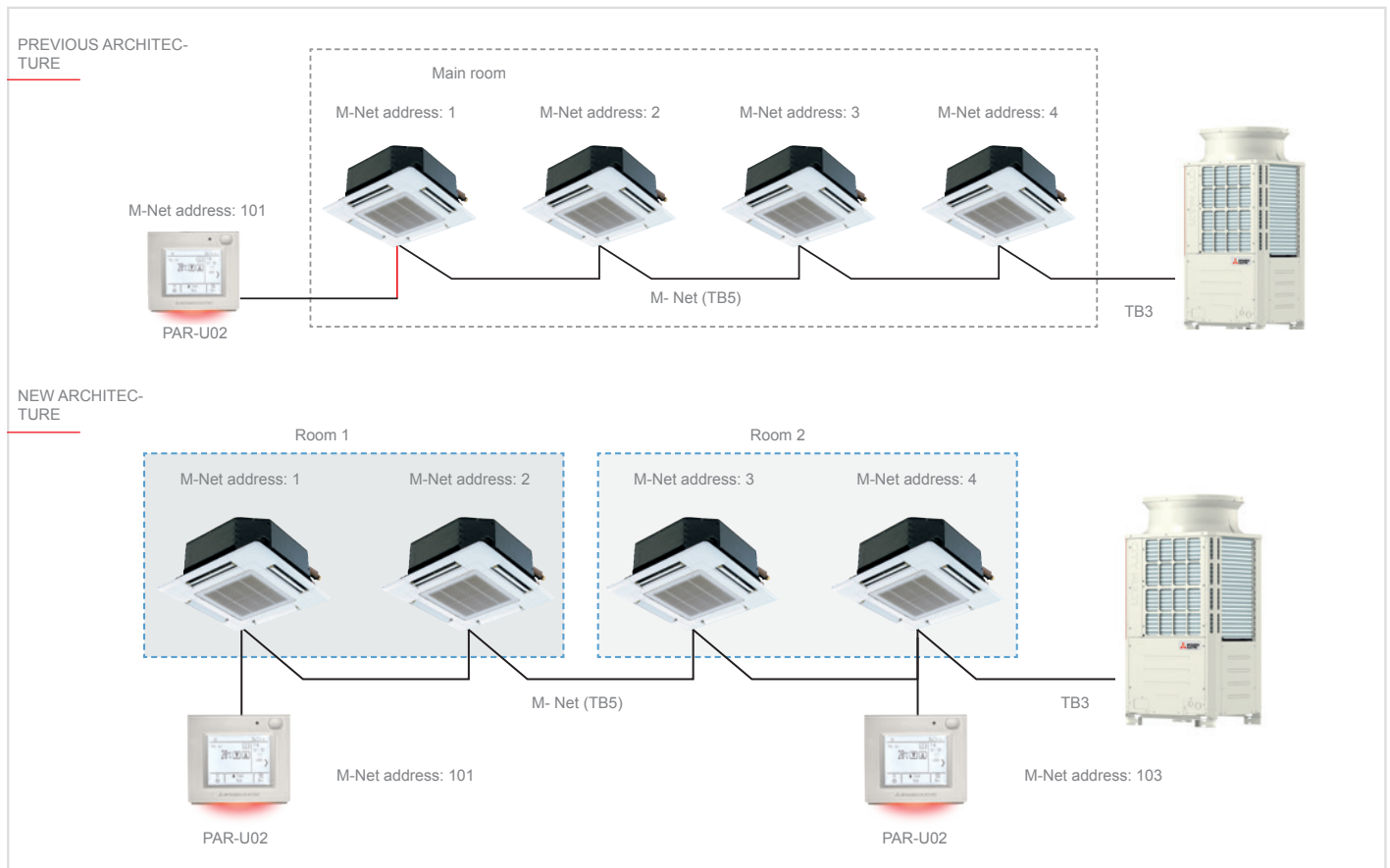
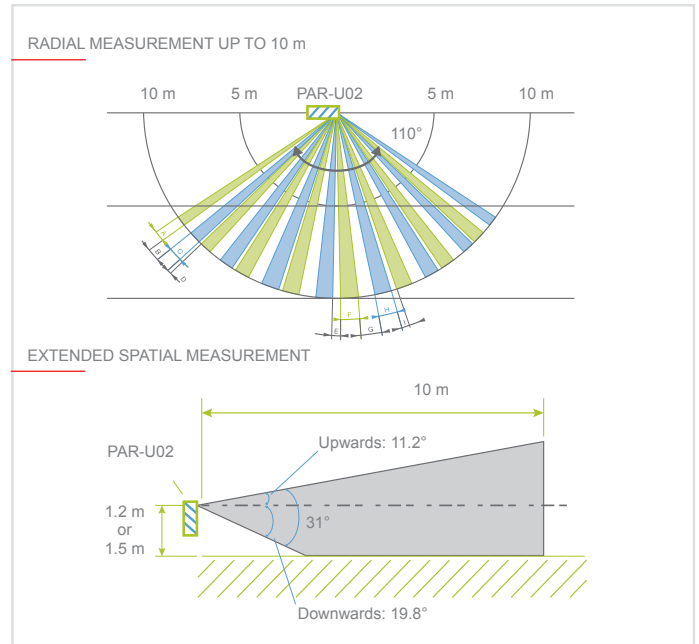

Application 2: Modifying Set-Point in relation to occupancy

The need

- Occupancy-based set point adjustment is required for the indoor units in order to save energy while still ensuring the comfort of the personnel using the spaces.

Solution

- The integrated occupancy sensor and the related operating logic enable occupancy-based control as shown in the following example:
 - In summer: T° set to 22°C if space is occupied, T° set to 24°C if space is vacant.
 - In winter: T° set to 21°C if space is occupied, T° set to 19°C if space is vacant.

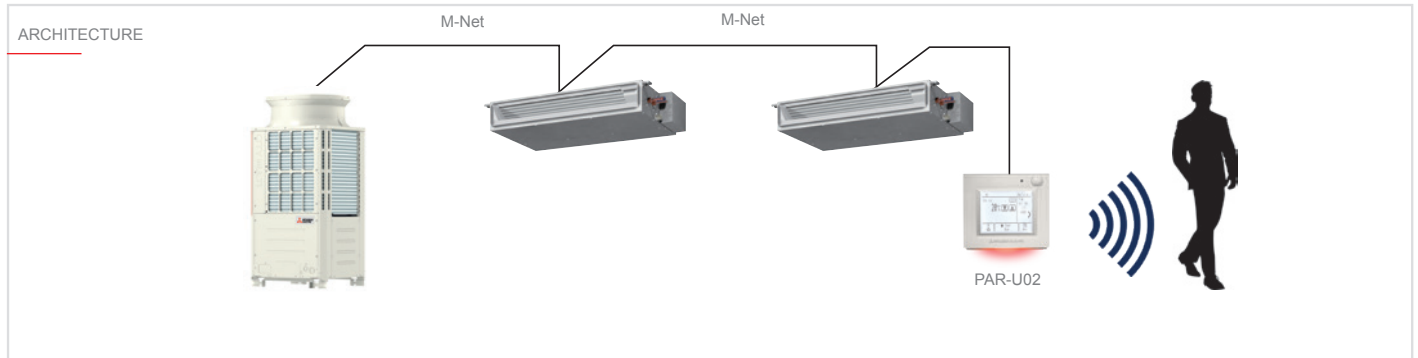

This function may be set from the PAR-U02 controller, from the "Energy Saving" menu.

Key Technologies

FUNCTION	DESCRIPTION	SETTING	DISPLAY
ON/OFF	Switch between ON and OFF	○	○
Operating mode	For switching between cooling/dehum./fan/auto/heating modes	○	○
Temperature setting	Modify set temperature. The settable temperature range varies depending on the model of indoor unit.	○	○
Set speed	Modifies fan speed. Fan speeds available vary depending on the model of indoor unit installed.	○	○
Air flow direction	Modify direction of air flow. Selectable air flow directions depend on the model of indoor unit.	○	○
Enable/disable local operations	The following functions may be disabled from specific settings on the centralised controller: ON/OFF, select operating mode, set temperature, fan speed, air flow direction, reset filter indicator lamp. The relative icon is shown on the display when a function is disabled.	×	○
Error	Displays error with relative unit address. The following information may be displayed in the event of an error: indoor unit model, serial number, contact information (e.g. phone number of dealer). An error code may not be displayed for certain errors.	—	○
Weekly timer	Used to set weekly ON and OFF times. Time is settable in 5 minute steps. Up to eight operating patterns are available per day. Not available when Timer ON/OFF mode is active.	○	○
Timer	Used to set ON and OFF times. <ul style="list-style-type: none"> • Time settable in 5 minute steps. • Both ON and OFF times are settable. • Auto-OFF timer: Used to set Auto-Off time. • Time may be set within a range from 30 to 240 minutes in steps of 10 minutes.	○	○
Night Set-back	Temperature ranges and start/end times are settable for Night Set-back mode.	○	○
Occupancy sensor for energy saving mode.	Operation in energy saving mode is activated when the occupancy sensor detects that the room is vacant. Four control modes are available: "On/Off", "Set temp.", "Vent", "Thermo-OFF". The light sensor may be used in conjunction with the occupancy sensor for more accurate detection of vacant room state.	○	○

○ Each group × Not available

PAR-FL32MA

WIRELESS REMOTE CONTROLLER



PAR-FL32MA wireless remote controller

- Usable to manage 1 group of up to 16 indoor units.
- Easy and intuitive with icon-based interface.
- Receiver connected simply with single non-polarised two-core wire.
- MA automatic addressing technology.
- Suitable for all types of indoor unit.
- Recommended for groups with only one indoor unit.
- Generic receiver for all indoor unit types: PAR-FA32MA.
- Specific corner receiver for 4-way PLFY-P VBM-E cassette units: PAR-SE9FA-E.

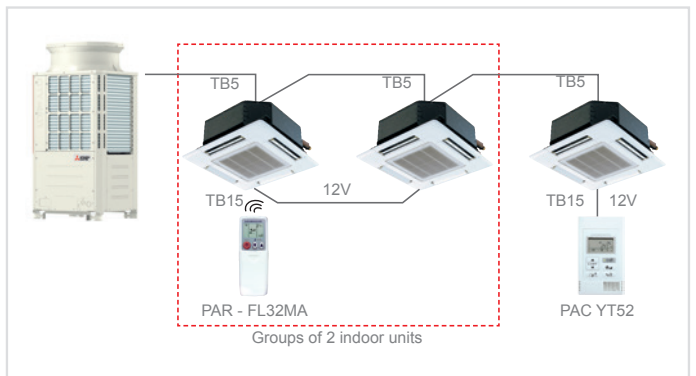

Compatibility		
	Receiver	Remote controller
PMFY-P*VBM PLFY-P*VLMD PFFY-P*VKM PEFY-P*VMR-E/R/VMH PFFY-P*VLEM/VKM/VLRM/VLRMM PEFY-P*VMS1(L) PEFY-P*VMA(L)	PAR-FA32MA	PAR-FL32MA

Compatibility		
	Receiver	Remote controller
PCFY-P*VKM	PAR-FA32MA	PAR-FL32MA
PKFY-P*VBM-E PKFY-P*VHM/VKM	Integrated	PAR-FL32MA

FUNCTION	DESCRIPTION	SETTING	DISPLAY
ON/OFF	Switch single group between ON and OFF modes	○	○
Temperature setting	Modify set temperature. The settable temperature range varies depending on the model of indoor unit.	○	○
Air flow direction	Modify direction of air flow. Selectable air flow directions depend on the model of indoor unit.	○	○
Timer	Usable to set one ON and one OFF event per day.	○	○
Enable/disable local operations	The following functions may be disabled from specific settings on the centralised controller: ON/OFF, select operating mode, set temperature, fan speed, air flow direction, reset filter indicator lamp. **A beeper sounds and an LED flashes as confirmation when an operation is disabled from the centralised controller.	×	○ ¹

○ Each group × Not available

PAR-SL101A-E

WIRELESS REMOTE CONTROL



Wireless remote control PAR-SL101A-E

- Compatible with PLFY-VFM and PLFY-VEM
- Backlighting
- Group with up to 16 units
- Direct/Indirect function with corner PAC-SF1ME-E (3D i-see sensor)
- Single vane control
- Temperature view and setting 0,5°C
- 3D i-see sensor compatible

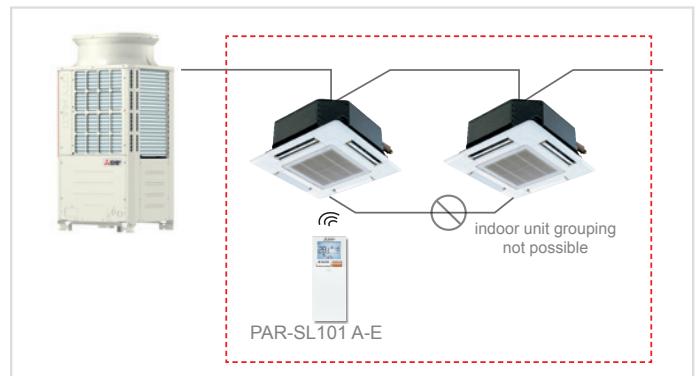

Compatibility		
	Receiver	Remote controller
PLFY-P/M VEM-E	PAR-SE9FA-E	PAR-SL101A-E
PLFY-P*VFM-E1	SLP-2FAL	

Key Technologies

--	--	--	--	--	--	--	--	--	--

Function	DESCRIPTION	SETTING	DISPLAY
ON/OFF	Switch between ON and OFF	○	○
Temperature setting	Modify set temperature. The settable temperature range varies depending on the model of indoor unit.	○	○
Air flow direction	Adjust air flow angle (4-Angle, Swing), Auto Louvre, ON/OFF Selectable air flow directions depend on the model of indoor unit.	○	○
Timer	Usable to set one ON and one OFF event per day.	○	○
Enable/disable local operations	The following functions may be disabled from specific settings on the centralised controller: ON/OFF, select operating mode, set temperature, fan speed, air flow direction, reset filter indicator lamp. *1A beeper sounds and an LED flashes as confirmation when an operation is disabled from the centralised controller.	×	○ ¹

○ Each group × Not available

PAR-W21MAA

ECODAN REMOTE CONTROLLERS



Remote controllers for HWS & ATW hydronic modules and for HWHP (Hot Water Heat Pump) PACKAGED systems

- PAR-W21MAA is specifically for HWS & ATW hydronic modules and for CAHV and CRHV PACKAGED Hot Water Heat Pump systems.
- Usable to manage 1 group of up to 16 indoor units.
- Easy and intuitive with icon-based interface.
- Simple connection with single non-polarised two-core wire.

- MA automatic addressing technology.
- Operating mode selection (Heating, Heating ECO, Hot water, etc.).
- Internal weekly timer.
- Customisable water temperature ranges for switching operating mode from local keypad.
- On-display service messages.





FUNCTION	DESCRIPTION	SETTING	DISPLAY
ON/OFF	Switch between ON and OFF	○	○
Operating mode	Switch between Domestic Hot Water/Heating/ECO Heating/Antifreeze/Cooling modes. Modes available depend on units installed. Switching limiting settings may be set and modified from the remote controllers.	○	○
Water temperature settings	Temperature settable (in steps of 1°C) within specific ranges for different modes: Heating 30°C - 50°C ECO Heating 30°C - 45°C Hot water 30°C - 70°C Antifreeze 10°C to 45°C Cooling 10°C to 30°C Settable ranges depend on the indoor units installed.	○	○
Temperature limiting	Limits temperature range settable from a remote controller.	○	○
Water temperature	10°C - 90°C in steps of 1°C Settable ranges depend on the indoor units installed.	×	○
Enable/disable local operations	The following functions may be disabled: ON/OFF, select operating mode, set water temperature, reset water recirculation notification.	×	○
Programmable operations	A number of different operations (ON/OFF, set water temperature) may be programmed to occur up to six times over the week (in steps of one minute).	○	○
Error	In the event of a error concerning a unit, the error code and unit identification are displayed.	×	○
Auto check (error log)	Search for most recent error log (press CHECK button twice).	○	○
Start test	Enable test mode, by pressing TEST button twice. The 'Start test' mode is only available with certain indoor units.	○	○
Change circuit water warning	Notifies the user that the circuit water must be replaced with a message specific to the relative unit Press CIR.WATER twice to clear the on-screen notification. This function is only available with certain indoor units.	○	○
Control lock function	The functions of the remote control may be locked or unlocked as follows: • Lock all functions • Lock all functions except for ON/OFF	○	○

○ Each group × Not available

PZ-62DR-EB NEW

LOSSNAY REMOTE CONTROL



PZ-62DR-EB remote control for Lossnay

- Specific remote control for Lossnay heat recovery units.
- Usable to manage one group of up to 15 Lossnay units.
- Easy and intuitive with icon-based interface.
- Simple connection with single non-polarised two-core wire.
- Internal weekly timer.
- Custom ventilation strategies for mode switching (Auto/recovery/bypass).
- Night purge function for active night-time ventilation in summer.
- On-display service messages.
- Backlit LCD screen.
- Energy management

3 Languages are added
Greek, Slovenian, Denmark

Compatibility
PZ-62DR-EB are compatible with both RVX and RVS.



*Not compatible with LGF

Dedicated PZ-62DR-EB wired controller

The new PZ-62DR-EB controller can be used to control all the functions of the LGH-RVS unit.

If the PZ-70CSW-E (optional) or PZ-70CSB-E (optional) CO₂ sensor is used, the carbon dioxide concentration in the room can be displayed on the control unit's display.

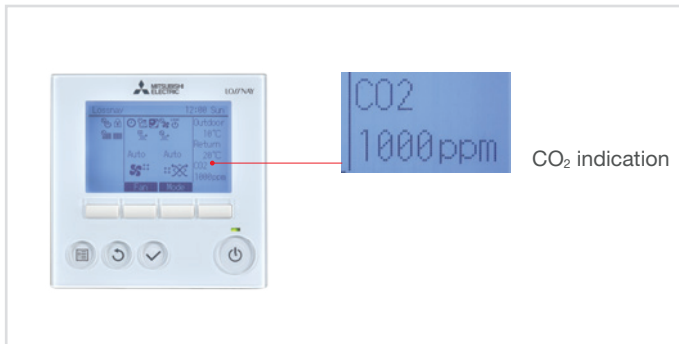

Function	PZ-62DR-E
Fan speed selection	4 fan speeds and Auto (Auto is available when using a CO ₂ sensor)
Control with a CO ₂ sensor	Yes (Fan speed automatically changes from 25% to 100% depending on the CO ₂ concentration*)
Ventilation mode selection	Energy recovery/Bypass/Auto
Night-purge	Yes
Function setting from remote controller	Yes
Bypass temp. free setting	Yes
Multi-stage air flow control	Yes (Both supply and exhaust fan speeds can be set separately from 25% to 100% in 5% pitches)
ON/OFF timer	Yes
Auto-off timer	Yes
Weekly timer	Yes
Fan speed timer	Yes
Operation restrictions (ON/OFF, ventilation mode, fan speed)	Yes
Operation restrictions (fan speed skip setting)	Yes
Screen contrast adjustment	Yes
Language selection	Yes
CO ₂ concentration indication	Yes (available when using a CO ₂ sensor)
Filter cleaning sign	Yes (maintenance interval can be changed)
Error indication	Yes (displays model name, serial number, contact information if they are input)
Error history	Yes
OA/RA/SA temp. display	Yes

* When using a CO₂ sensor. Upper and lower limits may be changed.

Centralised controls

In order to create a centralised installation, devices denominated centralised controllers must be used. These are devices which make it possible to plan, direct and coordinate the operation and functions of all the devices in the field (indoor units, remote controllers etc.).

A centralised controller must permit access, individually or collectively, to the the indoor units and remote controllers in the installation and be capable of controlling their operation (with timer programs, the ability to disable selected end-user functions etc.) in order to optimise the efficiency and efficacy of the entire installation.

This has been achieved by the innovative WEB Server 3 Diamonds (AE-200 and EW-50) centralised controller platform, which is based entirely on the same technology and languages used in the internet world.

A computer and a web page are the simplest way to view and use information. Implementing this concept in air conditioning applications offers the ability to monitor and manage air conditioning systems of any type, from a single air conditioner to the most complex installation.



Continuous technological innovation has driven an evolution in building-installation systems. And today, these systems use highly efficient data transmission architectures.

Embracing this reality and applying it in air-conditioning makes it possible to:

- Take full advantage of the potential of existing communication infrastructure;
- Design and realise distributed control logic system architectures;
- Create simple to use devices and clearly comprehensible user interfaces.

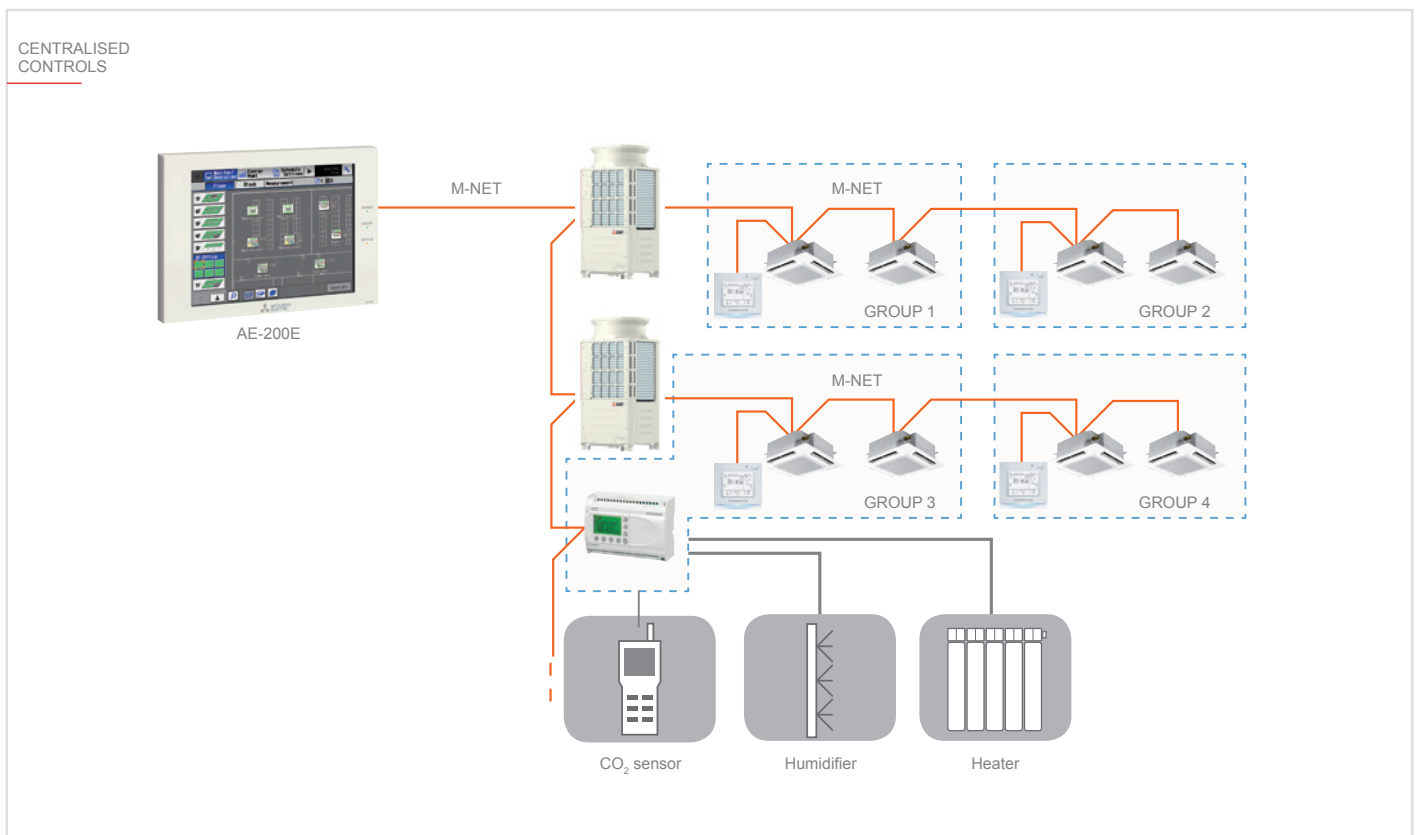
This is why Mitsubishi Electric chose Ethernet, the world's most widely used network standard, to enable communication between AE-and EW-50 WEB server centralised controllers and PCs.



Centralised controller functions	AE-200E	EW-50E	AT-50B
			
Function			
Interface	Touch screen/Browser	Browser	Touch Screen
Max. number of Groups/IUs	50/50*	50/50*	50/50
ON/OFF	•	•	•
Set Heat/Cool modes	•	•	•
Temperature setting	•	•	•
Dual Set Point	•	•	•
Fan speed	•	•	•
Air flow direction	•	•	•
Backlight	•	•	•
Error code display	•	•	•
Set Group	•	•	•
Set Block	•	•	•
Daily timer	•	•	•
No. of ON/OFF cycles per day	24	24	16
Weekly timer	•	•	•
No. of ON/OFF cycles per week	24x7	24x7	16x7
Timer setting resolution [min]	1	1	5
Optimised start	•	•	
Annual timer	•	•	
Sliding temperature	•	•	
Lossnay interlock	•	•	•
Set Lossnay ON/OFF	•	•	•
Set Lossnay fan speed	•	•	•
Restriction settings	•	•	•
Night Setback	•	•	•
Energy Management Data	•	•	
BACnet® interface	Native	Native	
AHC compatible	•	•	
RMI compatible	•	•	
Expandable	•	•	

*up to 200 with expansion



Key Technologies

Energy savings



Dual Setpoint

The new Dual Setpoint function makes it possible to preset setpoint temperatures for cooling and heating mode in a single operation.

On Y series heat pump models, this function means that it is no longer necessary to reset setpoint temperatures each time the operating mode of the unit is switched from Heating to Cooling mode and vice versa.

In R2 heat recovery systems, it is also possible to set an “energy saving” temperature band for AUTO mode, within which the system ventilates and performs no thermal air treatment (thermo off).

Setting a broader band increases energy savings, but permits larger temperature variations in the indoor space. Setting the two setpoint temperatures closer together creates a narrower thermo off band, prioritising comfort in the indoor space over energy savings.

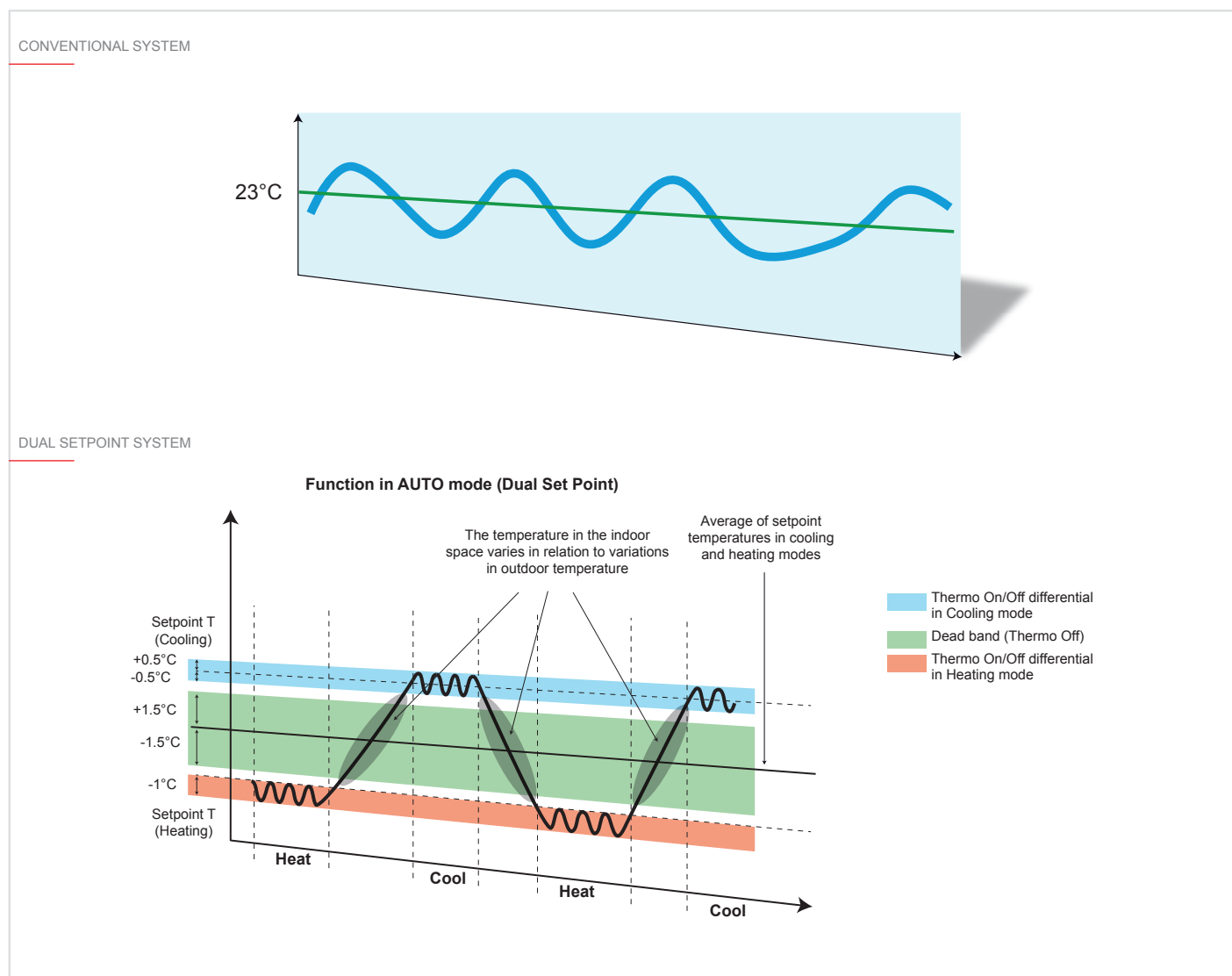

The width of the “thermo off” band depends on the setpoint temperatures set for the two operating modes (Cooling and Heating)



Night Setback Control - Maintenance temperature

The function also activates heating mode when, after the monitored group has stopped, the temperature in the room drops below the set lower limit. The function also activates cooling mode when, after the monitored group has stopped, the temperature in the room rises above the set upper limit.

The Night Set-back Control function is not available if the operating mode and temperature setting are modified from the remote control.

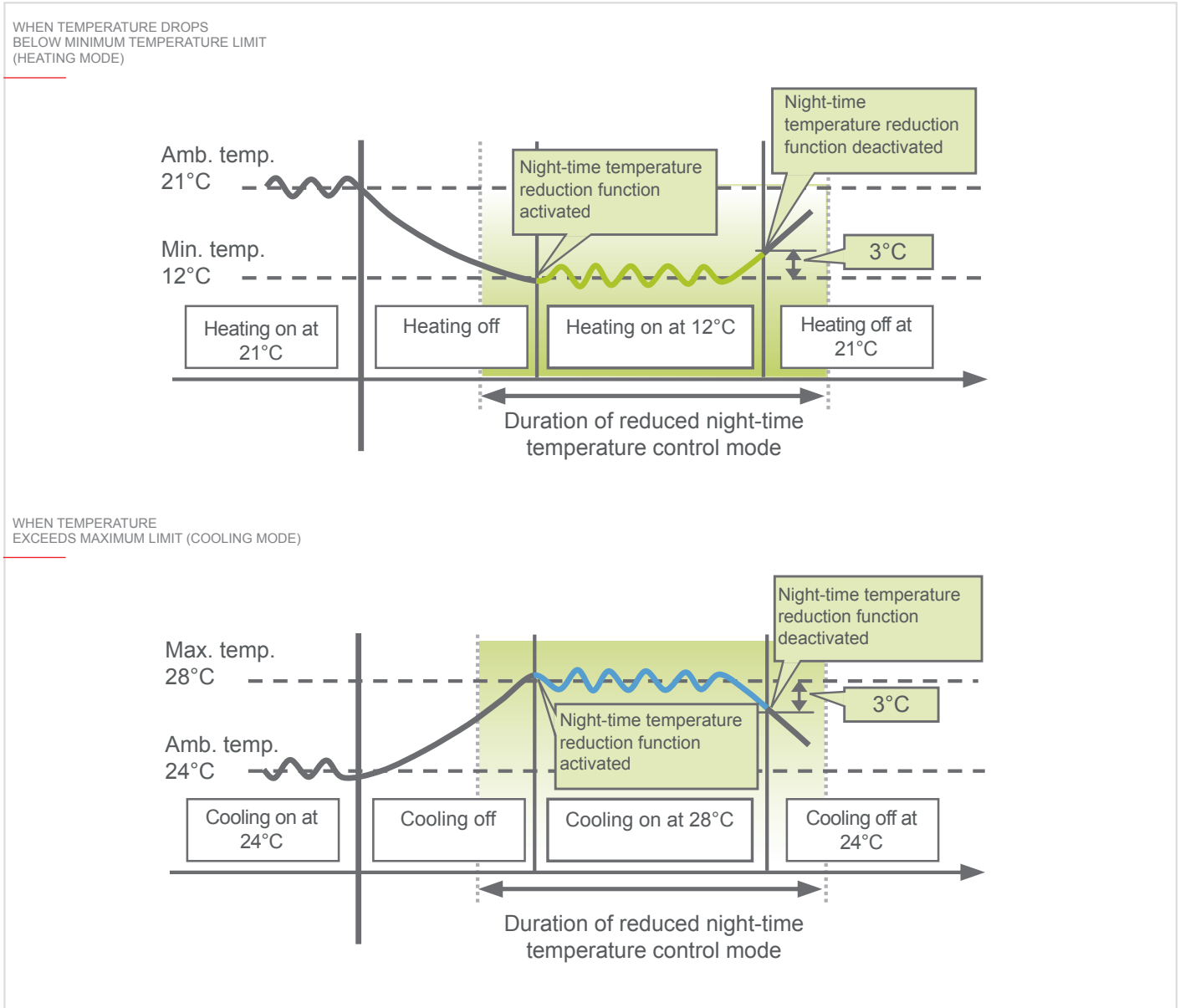

If the ambient temperature is measured in the same position as the indoor unit air intake, the temperature reading will not be precise when the unit is inactive. In this case, install a remote sensor (PAC-SE41TS-E) or use the built-in sensor of the remote control to move the temperature acquisition point.

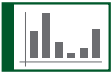

Energy Management

The Energy Management function displays parameters relative to the energy management of the installation (such as energy consumption, operating times, external temperature etc.) in graph form.

This data is saved in the internal memory of the centralised controller and may be exported as CSV format files. Information is logged in steps of 5 minutes, 30 minutes, one day, one month and one year. This lets the system administrator view values relative to individual groups, blocks or units for different time intervals, and compare graphs for different

machines, zones or time periods.

This function may be used for a number of different purposes, such as:

- Monitoring the operation of the installation in real time to determine current consumption and identify causes of energy wastage or malfunctions to permit prompt corrective action.
- Plan actions to improve the efficiency of the system and evaluate the efficacy of the measures implemented by comparing data from before and after.



Sliding temperature

The set temperature may be adjusted automatically in relation to the difference between the set temperature and the external temperature. In the case of indoor units installed in the foyer of a building, for example,

this temperature control function prevents persons from being exposed to sudden, large temperature differences, and the resulting thermal discomfort.

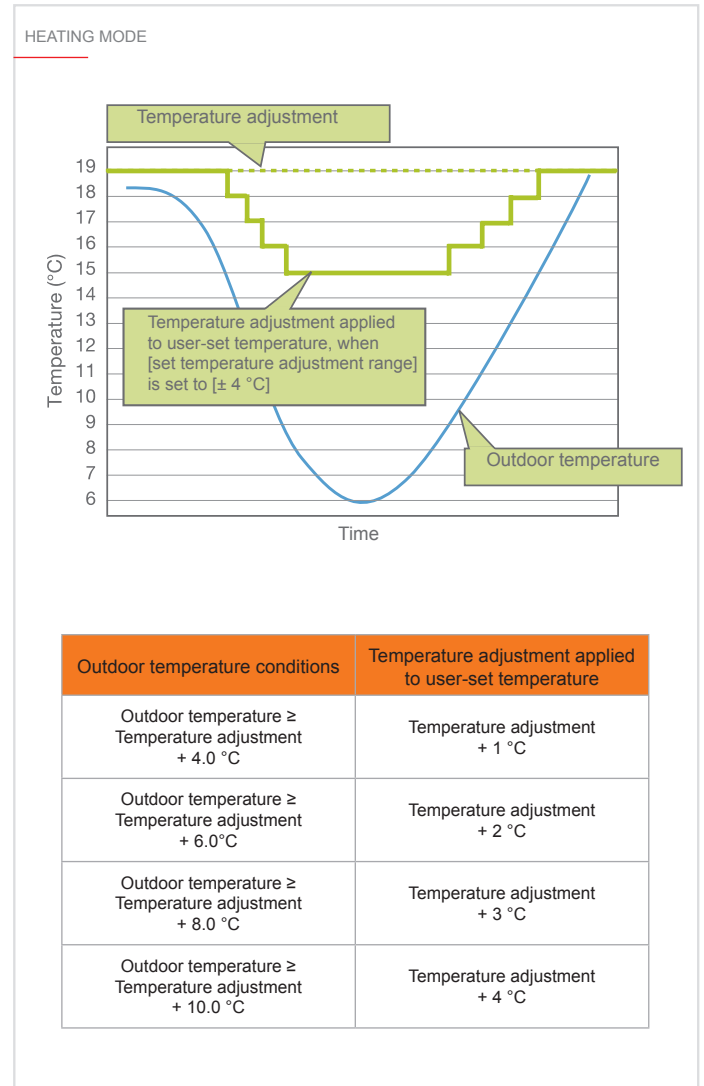
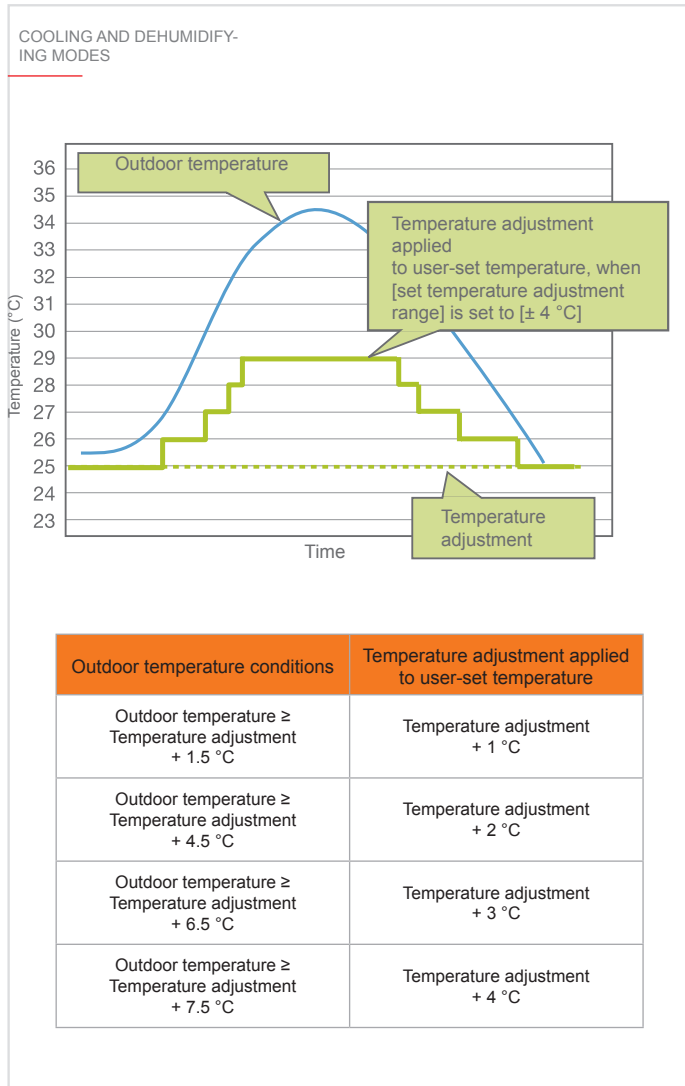

Optimised start

The “Optimised start” function automatically starts the installation or individual groups within the installation ahead of the programmed start time to ensure that the comfort conditions required by the timer schedule are met

The centralised controllers automatically acquire and save the timer

schedule setpoints, the daily ambient temperature and the setpoint attainment history over the previous days, and use these parameters to calculate the necessary pre-on time relative to the timer setting within a range from 5 to 60 minutes. The “Optimised start” function is available in both heating and cooling modes.

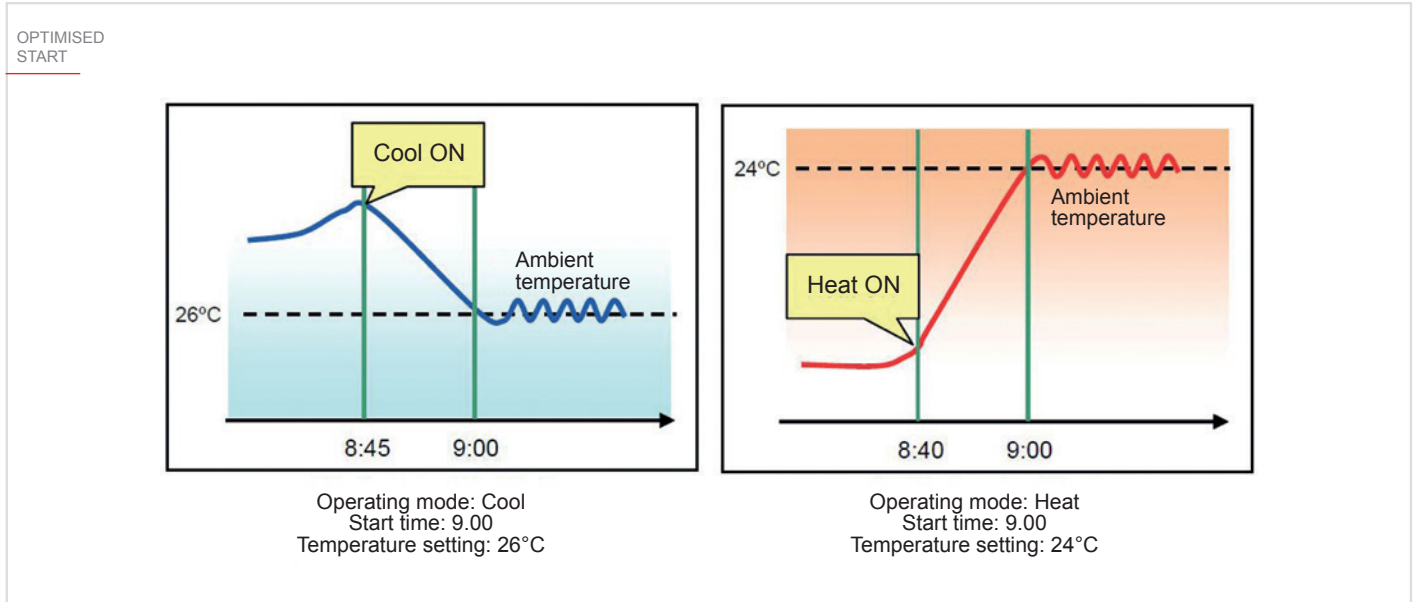

i The “Optimised start” and “Night Setback” (or “Maintenance temperature”) functions are fully integrable with and complementary to each another. Maintaining the temperature in the indoor space at an adequate temperature and activating the installation ahead of the programmed start time will ensure the required levels of occupant comfort are attained exactly as scheduled.

Defining settable temperature range

The setpoint range may be defined for the remote controls to limit the range of temperatures settable by users. This avoids waste, preventing individual units from being operated with non-optimal settings made erroneously in response to the subjective perception of the ambient temperature, while still ensuring adequate environmental comfort.

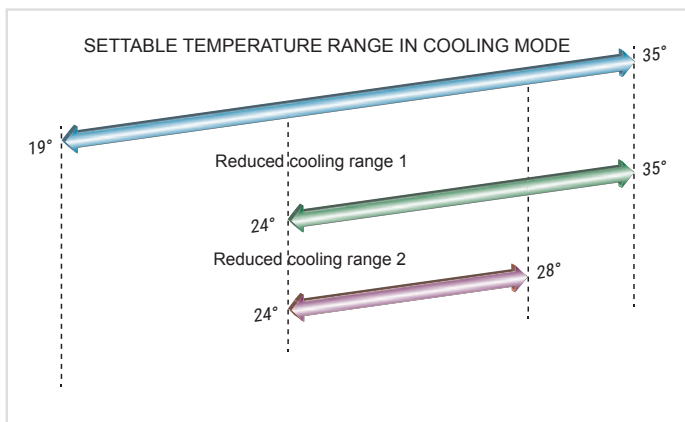

Functions

Night Mode

This function further reduces the noise produced by the outdoor unit by reducing the maximum fan speed and compressor frequency in consideration of the reduced demand for thermal power during night time operation.*



* In Silent Mode, the thermal and/or cooling capacity of the outdoor unit is limited.

Functions

Programming schedules

The automatic operation of the installation is programmable from a practical and versatile timer. Three timer functions are available: a daily timer, for programming events for the current day; a weekly timer, with settings applied in weekly cycles; and an annual calendar mode, for planning - well in advance, if needed - the operation of the installation on special days such as public holidays etc.

All three of these programming modes may be set for the same air conditioner and may overlap (with different mode schedules applicable for the same day). In this case, priority is given as follows:

- 1) Daily schedule
- 2) Annual schedule
- 3) Weekly schedule

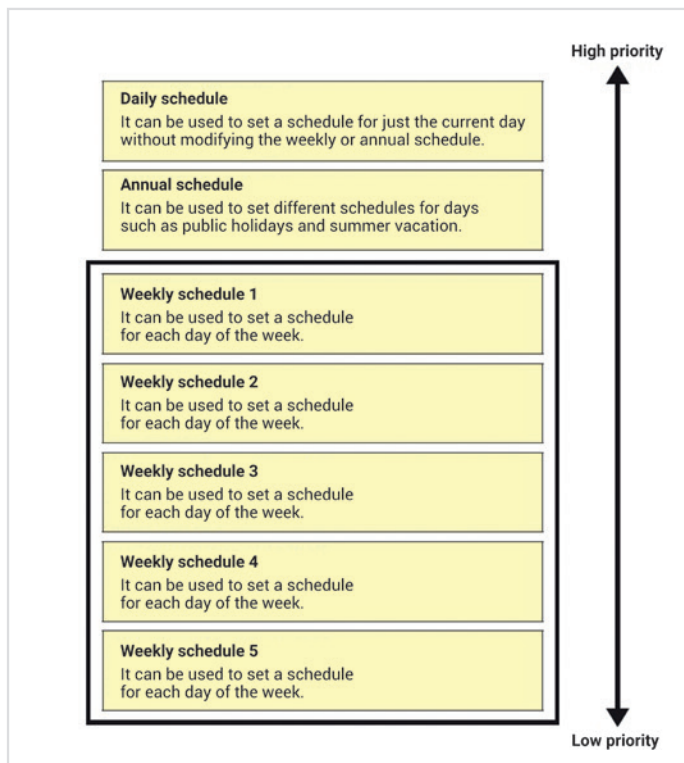

Daily Timer

Daily schedule

The daily schedule is only applicable for the current day. The schedule is cancelled automatically at midnight at the end of the day on which the schedule was programmed. This is the programming mode with the highest priority, meaning that if other settings (annual and/or weekly) are scheduled for the same day, they will be ignored. Schedules may be programmed for individual groups, for blocks (sets of groups) or for all the air conditioners connected to AE-200/EW-50 controller (All Groups mode).



Weekly Timer

Weekly schedule

The weekly schedule programming function may be used to plan the operation and settings of the installation for a week. Up to 5 weekly schedules may be defined to be applied at different periods during the year to follow changes in season, allowing the operation of the installation to be configured automatically for seasonal climate conditions. The operating mode, set points and on/off times are defined in schedules.



Early Timer

Annual schedule

The annual schedule programming function lets the user define "special" days, during which the installation is required to operate with different settings than those defined for the current weekly schedule. This function allows the administrator to programme the installation to automatically implement different settings on special days when the air conditioning requirements of the indoor spaces served by the installation differ from those applicable during normal operation due to closure for holidays or periods of low occupancy. Up to 52 special days may be set during the year.

ANNUAL SCHEDULE

JANUARY						
M	T	T	T	F	S	S
				1	2	3
4	5	6	7	8	9	10
11	12	13	14	15	16	17
18	19	20	21	22	23	24
25	26	27	28	29	30	31

FEBRUARY						
M	T	T	T	F	S	S
1	2	3	4	5	6	7
8	9	10	11	12	13	14
15	16	17	18	19	20	21
22	23	24	25	26	27	28
29						

MARCH						
M	T	T	T	F	S	S
	1	2	3	4	5	6
7	8	9	10	11	12	13
14	15	16	17	18	19	20
21	22	23	24	25	26	27
28	29	30	31			

APRIL						
M	T	T	T	F	S	S
				1	2	3
4	5	6	7	8	9	10
11	12	13	14	15	16	17
18	19	20	21	22	23	24
25	26	27	28	29	30	

MAY						
M	T	T	T	F	S	S
						1
2	3	4	5	6	7	8
9	10	11	12	13	14	15
16	17	18	19	20	21	22
23	24	25	26	27	28	29
30	31					

JUNE						
M	T	T	T	F	S	S
		1	2	3	4	5
6	7	8	9	10	11	12
13	14	15	16	17	18	19
20	21	22	23	24	25	26
27	28	29	30			

JULY						
M	T	T	T	F	S	S
				1	2	3
4	5	6	7	8	9	10
11	12	13	14	15	16	17
18	19	20	21	22	23	24
25	26	27	28	29	30	31

AUGUST						
M	T	T	T	F	S	S
1	2	3	4	5	6	7
8	9	10	11	12	13	14
15	16	17	18	19	20	21
22	23	24	25	26	27	28
29	30	31				

SEPTEMBER						
M	T	T	T	F	S	S
			1	2	3	4
5	6	7	8	9	10	11
12	13	14	15	16	17	18
19	20	21	22	23	24	25
26	27	28	29	30		

OCTOBER						
M	T	T	T	F	S	S
					1	2
3	4	5	6	7	8	9
10	11	12	13	14	15	16
17	18	19	20	21	22	23
24	25	26	27	28	29	30
31						

NOVEMBER						
M	T	T	T	F	S	S
	1	2	3	4	5	6
7	8	9	10	11	12	13
14	15	16	17	18	19	20
21	22	23	24	25	26	27
28	29	30				

DECEMBER						
M	T	T	T	F	S	S
			1	2	3	4
5	6	7	8	9	10	11
12	13	14	15	16	17	18
19	20	21	22	23	24	25
26	27	28	29	30	31	

Weekly 1 Weekly 2 Weekly 3 Weekly 4 Special day

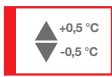

View and set setpoint temperatures in 0.5°C steps

The goal of Mitsubishi Electric is to offer a better quality of life through innovative products. Mitsubishi Electric was the first manufacturer to introduce the capability of viewing and setting setpoint temperatures in 0.5°C increments, for unparalleled comfort calibrated with decimal precision by the user.

This function gives the user a greater sense of control and, therefore, comfort, by offering a wider and more precise choice of settable temperatures.



Monitor quantity of refrigerant in system

WEB Server centralised controllers may be used to run a test function for periodically checking the quantity of refrigerant in each outdoor unit circuit. This function is performed by a software application which measures the temperature and pressure variables of the system to indirectly calculate the level of refrigerant.

This function is only accessible from the Web and is selectable for individual outdoor units. Once the routine is launched, a test cycle is run lasting from 30 minutes to 1 hour, during which the system configures the indoor units to operate in specific modes that cannot be modified by the user.

The routine consists of 10 cycles, and produces a qualitative outcome with three possible levels (High, Normal and Low).



The indirect refrigerant quantity monitoring procedure is intended to simplify the overall management of the system but is not a substitute for the inspection procedures required by the EC regulation 842/2006 (or F-Gas directive).

The ambient conditions (temperature/humidity) during the test cycle should also be taken into consideration.



AT-50B

CENTRALISED SYSTEM CONTROLLER



AT-50B centralised system controller

The new AT-50B centralised controller clearly belongs to the family of new Mitsubishi Electric control systems (AE-200, PAR-40MAA), with a gloss finish, glass-effect front panel and a modern, elegant design making it the ideal controller for residential applications.

The AT-50B features a backlit 5" touch screen allowing the user to monitor, configure and manage up to 50 indoor units or groups viewable in grid, list or group mode. Two programmable function buttons settable by the user for direct access to a choice of functions intended specifically for saving energy and ensuring that the VRF-HVRF CITY MULTI functions correctly.

- 5" backlit LCD touch screen.
- Usable to manage 50 groups of up to 50 indoor units.
- Individual or collective group control, with groups displayed in grid, list or group format.
- Dual Setpoint function
- Two weekly timers (for seasonal switching) and one daily timer.

- Simple connection with single non-polarised two-core wire.
- ME M-Net addressing technology.
- Two function buttons programmable to access any of a choice of functions (Night Set-back, weekly timer setting, switch operating mode, adjustable temperature range restriction, local restrictions).
- Recommended for controlling a single system.
- The PAC-SC51KUA external power supply is needed for controlling more than one system.

Technical specifications

MODEL	DIMENSIONS (L X H X W)	WEIGHT	ELECTRIC POWER SUPPLY	M-NET UNIT POWER CONSUMPTION
AT-50B	180 x 120 x 30 mm	500 g	17-32 VDC (M-Net connection)	4 M-Net unit

ARCHITECTURE

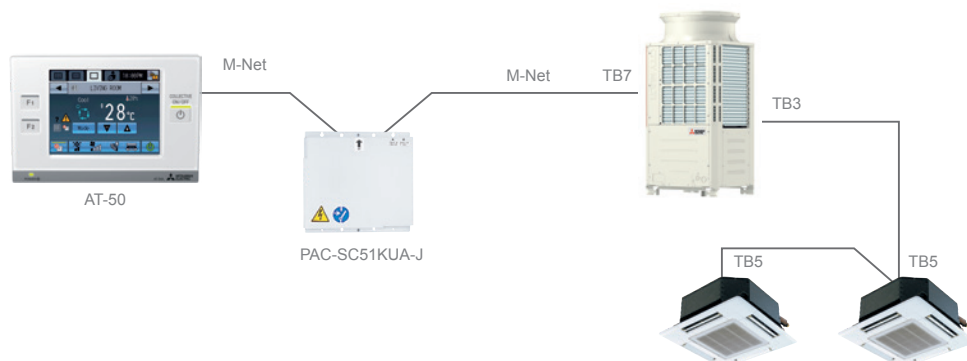

Key Technologies



FUNCTIONS	DESCRIPTION	SETTING	DISPLAY
ON/OFF	Switches air conditioning units on and off. The LED on the Collective ON/OFF button lights when one of more unit is in use and extinguishes when all the units are off.	○	○
Operating mode	Switches between the different operating modes available, which depend on the units installed. Air conditioning units: Cool./Dehum./Auto(*)/Vent./Heat. Lossnay units: Heat recovery/Bypass/Auto Air-Water units (PWFY): Heat., ECO Heat., Hot Water, Antifreeze, Cool. *Auto mode only available for CITY MULTI R2 and WR2 units	○	○
Temperature settings	Used to modify temperature settings. The settable temperature range depends on the model of indoor unit installed.	○	○
Enable/disable local operations	The following remote control functions may be disabled from specific settings on the centralised controller: ON/OFF, select operating mode, set temperature, fan speed, air flow direction, reset filter indicator lamp.	○	○
Error	The LED on the Collective ON/OFF button flashes in the event of an error on the AT-50B controller unit or any of the units or control units it controls. In the event of an error relative to indoor or LOSSNAY units, the icon for the relative group appears in the HOME screen. The error code may be viewed and reset from the Status List screen.	×	□○
Ventilation (independent)	Switches between Bypass/Heat recovery/Auto modes for the Lossnay unit.	○	○
Ventilation (interlocked)	The Lossnay ventilation unit starts automatically when the relative interlocked indoor unit starts.	○	○
Settable temperature range restrictions	Limits for the user settable temperature range may be defined for a group for cooling, heating and auto modes. This function is not available with the MA controller. Availability depends on the model of indoor unit installed.	○	○
External inputs/outputs (emergency shut-off etc.)	Allows the following activities to be configured and monitored by using an optional adapter for external input and output signals (PAC-YT51HAA, purchasable separately): Input: Level signal: "ON/OFF", "Emergency shut-off". Impulse signal: "ON/OFF", "Enable/disable local remote control". Output: "ON/OFF", "Error/Normal"	○	○
Weekly/daily schedule	Lets the user programme a weekly schedule for each group. Up to 16 of the following event types may be set in a schedule: ON/OFF, select mode, set temperature, set fan speed, set air direction, enable/disable local operations. Up to 12 schedules are available for the Weekly Schedule timer mode. Up to 5 schedules are programmable for Daily Schedule timer mode.	○	○

○ Each group □ Each unit ○ Collective × Not available



WEB Server centralised controllers

The management and supervision technology used for VRF-HVRF CITY MULTI systems is based on continuously evolving solutions borrowed directly from the Internet.

Ethernet - A global standard

Ethernet is the most widely used local area data communication network technology in the world. The key advantages of this communication technology are its low costs and simplicity of installation and operation.

Conceived originally for connecting PCs only, over time, the Ethernet network has grown to become the most widely used means for connecting not only other office devices (printers, fax machines, scanners, photocopiers), but also for connecting a multitude of other devices and transmitting a wide variety of different types of signal, from audio and video signals to, in the case of Mitsubishi Electric applications, data for WEB Server 3D centralised controllers.

The main reason for choosing this technology is that it makes it possible to use an existing single wired network extending throughout the entire building.

A network connecting a geographically limited area is denominated LAN (Local Area Network). A LAN network is often limited locally to a single site. The term WAN (Wide Area Network) indicates a set of devices or LAN networks connected over an extended geographic area. These may often be connected either by telephone line or with other forms of connection (such as broadband ADSL, fibre optic lines or satellite link). One of the largest existing WAN networks is the internet.

What is a WEB Server?

The primary function of a WEB Server device is to deliver web pages in response to requests from network clients. This means being capable of delivering HTML documents and all other types of additional content which may be included in these document, such as images, styles and JavaScripts.

A client, which may simply be a standard web browser such as Internet Explorer®, initiates communication by sending an HTTP request to the Web server. The Web server then responds by delivering the requested content. This means that it is not necessary to install any additional software on the client, which may therefore be any PC (not necessarily dedicated to this application) with internet access.

Mitsubishi Electric WEB Server centralised controllers use Ethernet as the data link protocol for LAN (Local Area Network), via a specific RJ-45 connection indicated for use with the TCP/IP suite of internet protocols.

To enable this communication, an IP network address must be assigned to each WEB Server centralised controller connected to the network.



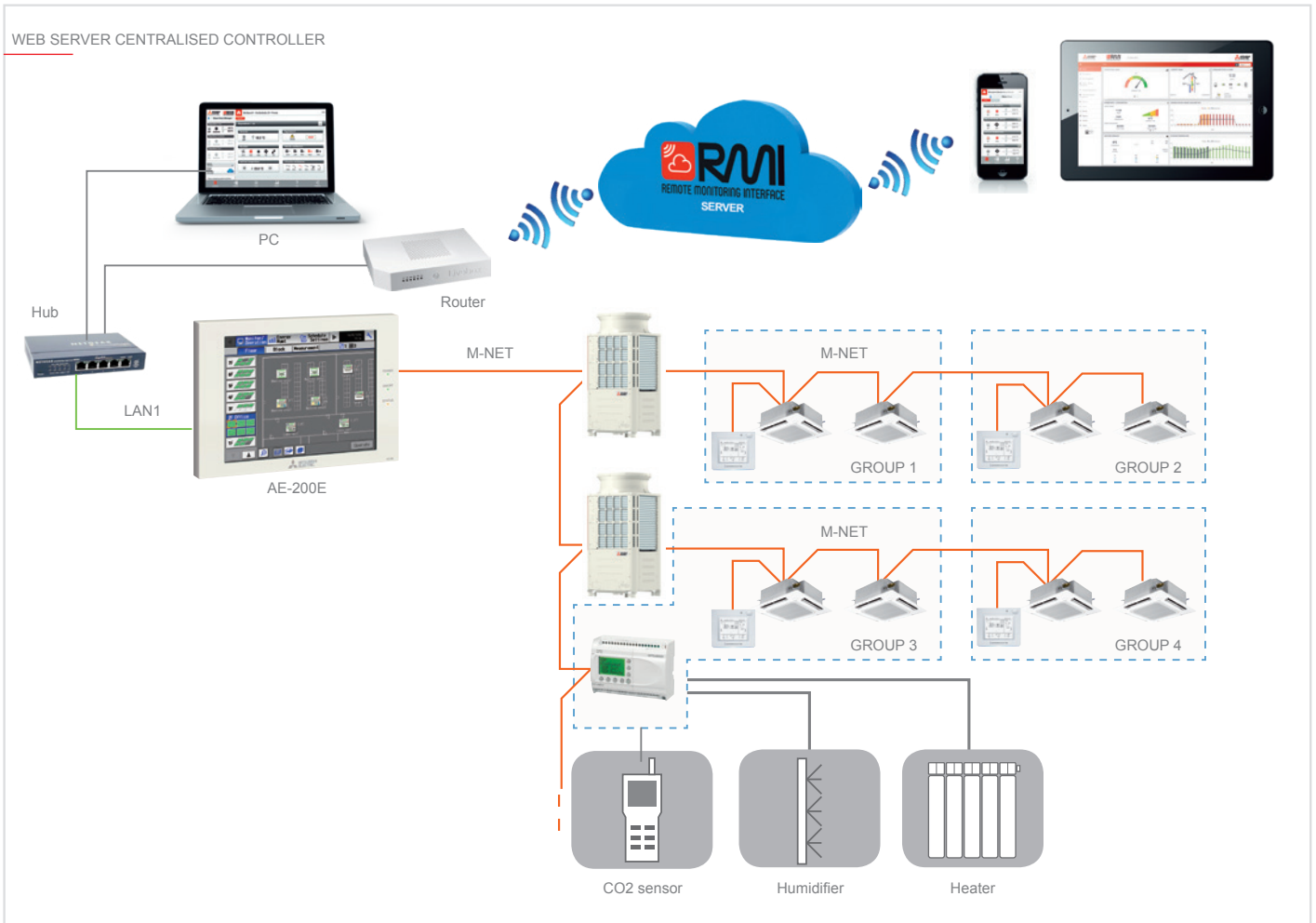

Web Browser monitoring and control functions

WEB Server centralised controllers make it possible to monitor and manage the operating parameters of all the indoor units in the installation from any PC on the same local network (LAN or Wi-Fi network of controller) via a web browser.

From this screen, the administrator may also check for malfunctioning indoor units and prevent units from being unintentionally left running for prolonged periods of time.

WEB BROWSER MONITORING AND CONTROL FUNCTIONS



Management, functional and monitoring capabilities of new Mitsubishi Electric controller systems

WEB Server centralised controllers support the management, operational and monitoring capabilities of all the new functions offered by the new PAR-U02MEDA remote controller. Information concerning occupancy, light levels, relative humidity in the indoor space and dual setpoints etc. is accessible directly from the display and via the WEB.



Integrated management of impulse meters

WEB Server centralised controllers are capable of acquiring the output signals from wall or electrical cabinet mounted digital impulse consumption meters. With the centralised controller, it is now possible to monitor the consumption of the installation with any electric power (WHM), water, and gas consumption meters and calorimeters producing an impulse type output signal.

Up to 4 digital meters may be connected to each individual centralised controller. The administrator may monitor the status of the meters connected to each controller and:

- View real time consumption values
- View consumption graphs
- Export consumption billing data in CSV format for consumption apportioning (CHARGE).

CHARGE consumption metering and apportioning system

The Charge consumption monitoring and apportioning system may be used to meter the consumption of electric power, thermal power and water for air conditioning, air and/or water heating and domestic hot water production with a Mitsubishi Electric VRF-HVRF CITY MULTI system, and calculate individual usage values.

The AE-200 and EW-50 CHARGE systems use proprietary Mitsubishi Electric calculation and apportioning methods. This consumption apportioning method indicates the consumption parameters of each user as percentages of the total consumption of the system. Consumption values, as percentages and kWh, may be calculated separately for:

- Indoor units
 - Ecodan HWS Hydronic Modules
 - Ecodan ATW Hydronic Modules
- See paragraph relative to Technical Services for more information.

Unit error log

The unit error log displays a list of the last 64 unit errors for each AE-200/ EW-50, complete with the date and time of detection of the error, the error code and the address of the unit from which the error originated.



Error list

List of currently active errors.

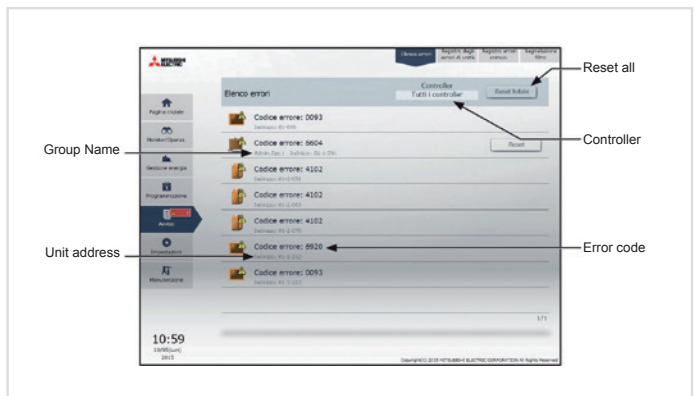

RMI Ready



WEB Server centralised controllers perform the crucial role of acquiring and monitoring data via the M-Net data transmission bus linking all the components of the VRF-HVRF CITY MULTI, Mr.

Slim or Residential system. A router (available as wired ADSL or 3G Mobile versions) creates a secure, protected communication channel with the RMI Server. The modular flexibility of the RMI Server makes it possible to store enormous volumes of data, which is acquired, processed and archived for access from portable devices.

This infrastructural complexity, combined with superior processing, management and security capabilities, is encapsulated in an extremely user friendly concept, to help users optimise the energy usage of their systems.

BACnet® connection

WEB Server centralised controllers may be connected directly to a home automation system using the BACnet® protocol. These units have two ethernet cable ports, for connection respectively to the local LAN network dedicated to the air conditioning system and the LAN network of the the BMS. This makes it possible to integrate the Mitsubishi Electric installation in a home automation system without the addition of a dedicated interface board.



AE-200E

WEB SERVER - 3D TOUCH CONTROLLER CENTRALISED CONTROLLER



WEB SERVER – 3D TOUCH Controller centralised controller (AE-200E)

The new WEB Server 3D TOUCH Controller centralised controller is an evolution of the AG-150A, the first centralised controller on the market to introduce typical BMS functions such as installation layout map display modes. While based on the same technology as its predecessor, the new controller offers even more flexibility for compatibility with future applications.

3D TOUCH Controller represents the state of the art in Mitsubishi Electric controller technology, and boasts class beating functions and features.

- Generously sized backlit 10.4" SVGA colour touch screen with graphic layout display function.
- Built-in 240V AC 50 / 60 Hz power supply.
- Stand-alone configuration: for managing up to 50 indoor units in total.
- Extended configuration: for managing up to 200 indoor units (with three EW-50 expansion modules)
- Individual or collective control of groups, blocks or zones.
- Ethernet interface for connection to BMS supervisor systems.

- Integrated WEB server software for management using Internet Explorer®.
- Integrated 2 GByte SD memory card for storing system data
- Power consumption data for billing downloadable via internet connection.
- BACnet® connection
- Complete support for all advanced RMI platform functions for energy consumption monitoring and for multi-installation and multi-user management.
- Temperature setpoints viewable and settable with a resolution of 0.5°C.
- Energy saving functions: Maintenance temperature, Sliding temperature, Optimised start, Dual Setpoint.
- M-Net interfacing with Ecodan package Hot Water Heat Pump systems (CAHV and CRHV).
- E-mail fault notification function.
- Complete support for all advanced RMI platform functions for energy consumption monitoring and for multi-installation and multi-user management.
- **RMI READY** Complete support for all advanced RMI platform functions for energy consumption monitoring and for multi-installation and multi-user management.

Technical specifications

MODEL	DIMENSIONS (H X L X W)	WEIGHT	ELECTRIC POWER SUPPLY	M-NET UNIT POWER CONSUMPTION
AE-200E	200 x 284 x 65 mm	2.3 kg	100-240 VDC (M-Net connection)	4 M-Net unit

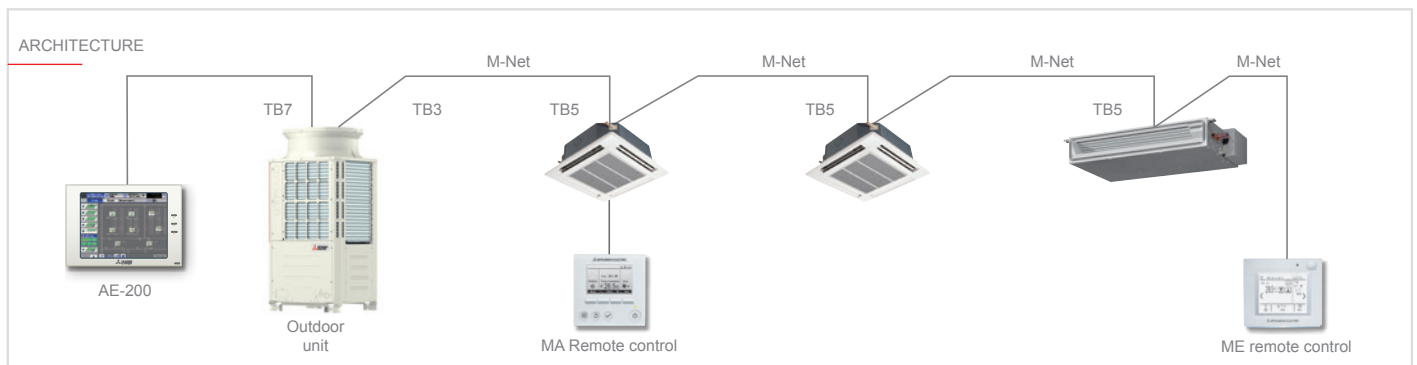

Graphic Layout Display Function

The 3D TOUCH Controller boasts a generously sized, backlit 10.4" colour SVGA touch screen allowing the user to interact comfortably, easily and intuitively with the system. Temperatures are viewable and settable with a resolution of 0.5°C, while

a Dual Set-Point function is also available.

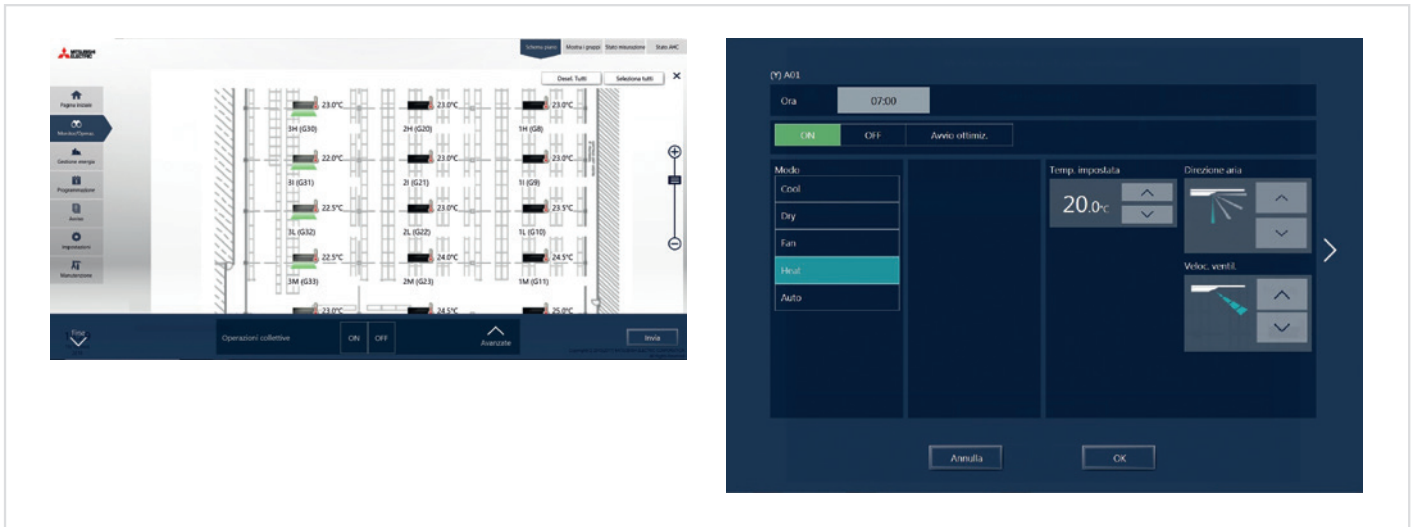

Power and flexibility in a compact device

While measuring practically the same as the previous AG-150, the new 3D TOUCH Controller WEB Server centralised controller offers a larger screen area, greater processing power and expandable flexibility for future applications.

RMI Ready



The WEB Server **3D TOUCH Controller** centralised controller performs the crucial role of acquiring and monitoring data via the M-Net data transmission bus linking all the components of the VRF-HVRF CITY MULTI, Mr. Slim or Residential system.

A router (available as wired ADSL or 3G Mobile versions) creates a secure, protected communication channel with the RMI Server. The modular flexibility of the RMI Server makes it possible to store enormous volumes of data, which is acquired, processed and archived for access from portable devices.

This infrastructural complexity, combined with superior processing, management and security capabilities, is encapsulated in an extremely user friendly concept, to help users optimise the energy usage of their systems.

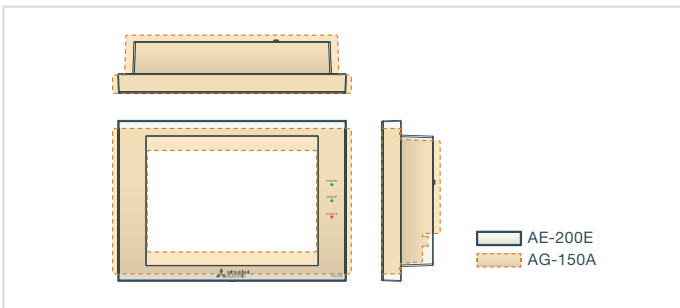



Key Technologies

FUNCTION	DESCRIPTION	SETTING	DISPLAY
Number of units controllable	Up to 50 units/50 groups.		
ON/OFF	Switch the units in the installation on or off.	○ ◎ △ ●	○ ◎
Operating mode	Switch between the different operating modes available, which depend on the units installed. Air conditioning units: Cool./Dehum./Auto(*)/Vent./Heat. Lossnay units: Heat recovery/Bypass/Auto CAHV/CRHV units, Air-Water units (PWFY): Heat., ECO Heat., Hot Water, Antifreeze, Cool. (**). *Auto mode only available for CITY MULTI R2 and WR2 units **For PWFY units only.	○ ◎ △ ●	○
Temperature setting	Used to modify temperature settings. The settable temperature range depends on the model of indoor unit installed.	○ ◎ △ ●	○
Fan speed setting	Models with 4 settable fan speeds: Hi/Mid-2/Mid-1/Low. Models with 3 settable fan speeds: Hi/Mid/Low. Models with 2 settable fan speeds: Hi/Low. The settable fan speeds and modes (including Auto mode) depend on the model of indoor unit.	○ ◎ △ ●	○
Air flow direction setting	Sets the direction/mode of the air flow (with up to 5 directions and with Swing and Auto modes).	○ ◎ △ ●	○
Programme	For programming daily/weekly/seasonal weekly/annual timer schedules. The following functions and modes are settable: ON/OFF, operating mode, temperature setting, disable remote control, air flow direction.	○ ◎ △ ●	○
Enable/disable local operations	The following remote control functions may be disabled from specific settings on the centralised controller: ON/OFF, select operating mode, set temperature, fan speed, air flow direction, reset filter indicator lamp.	○ ◎ △ ●	○
Intake air temperature	Measures the intake air temperature only when the indoor unit is on.	×	○
Error	In the event of an error concerning a unit, the error code and the unit involved are displayed.	×	□ ◎
Test run	Activates the air conditioning unit in Test run mode.	○ ◎ △ ●	○
Ventilation interlock	The Lossnay ventilation unit starts automatically when the relative interlocked indoor unit starts.	○ ◎ △ ●	○
External Outputs/Inputs	Allows the following activities to be configured and monitored by using an optional adapter for external input and output signals (PAC-YG10HA-E): Input: Level signal: "ON/OFF", "Emergency shut-off". Impulse signal: "ON/OFF", "Enable/disable local remote control". Output: "ON/OFF", "Error/Normal"	◎	◎
Energy management	Bar graphs: Indoor unit electric power usage; vent. Time; Thermo-ON time (TOTAL, Cool., Heat.), for hourly, daily and monthly values. Line graphs: External temperature; ambient temperature, set temp. (heat., cool.) Input from PAC-YG63MCA and temperature from AHC	×	□ ○ ●
Advanced control HVAC (AHC)	The status of the AHC system can be monitored only.	×	○
ME remote control	The status of the sensor incorporated in this controller may be monitored.	×	○
Smartphone/Tablet	AE-200/EW-50 controllers may be monitored and controlled via browser on iOS and Android OS devices.	○	○
New web design	New web interface developed to be even more user friendly.	○ ◎ △ ●	○
Initial configuration software	Initial configuration may be set up with no connection to the AE-200/EW-50 controller.	×	×
Consumption apportioning	The AE-200 controller is capable of calculating consumption values for separate users (requires PRO-3DCHARGE or RMI CHARGE consumption apportioning system).	●	□ ●
BACnet® communication	The ASN/ASHRAE 135-2010 (ISO16484-5) protocol is supported and approved by BTL.	○	×

○ Each group □ Each unit ● Each block △ Each floor ◎ Collective × Not available

EW-50E

WEB SERVER 3D BLIND CONTROLLER CENTRALISED CONTROLLER



WEB server – 3D BLIND Controller centralised controller

- “Black Box” version (no display).
- Compact dimensions (external 230V AC power supply).
- Usable to manage 50 groups for a total of up to 50 indoor units.
- Individual or collective group control.
- Ethernet interface for connection to supervisor systems.
- Integrated WEB server software for management using Internet Explorer®.
- Simplified connection, with single non-polarised two-core wire, using ME technology.
- Integrated 2 GByte SD memory card for storing system data.

- Direct management of 4 impulse meters with no external interface.
- Status indicator LED indicating data transmission status and/or errors.
- Consumption data for billing downloadable via internet connection.
- A wide choice of energy saving functions offered as standard, with additional optional functions accessible with PIN code licenses.
- E-mail fault notification function.
- Complete support for all advanced RMI platform functions for energy consumption monitoring and for multi-installation and multi-user management.
- **RMI READY** Complete support for all advanced RMI platform functions for energy consumption monitoring and for multi-installation and multi-user management.

Technical specifications

MODEL	DIMENSIONS (H X L X W)	WEIGHT	ELECTRIC POWER SUPPLY	M-NET UNIT POWER CONSUMPTION
EW-50E	172 x 209 x 92 mm	1.7 kg	110-240V AC 50/60 Hz	4 M-Net units

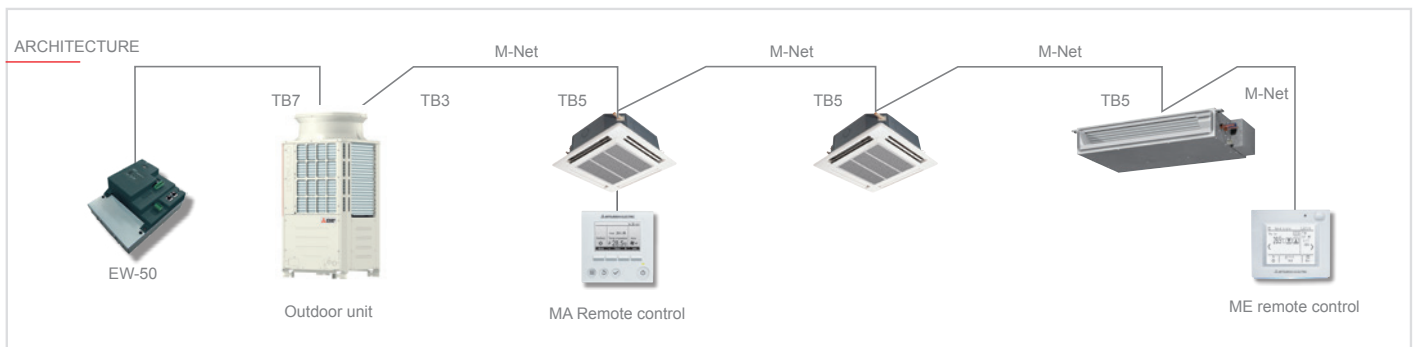

i The EW-50 centralised controller may be used effectively via the new Web Browser interface and the Personal Web app, which allows the installation to be controlled from a smartphone or tablet without a dedicated display screen as on the AE-200.

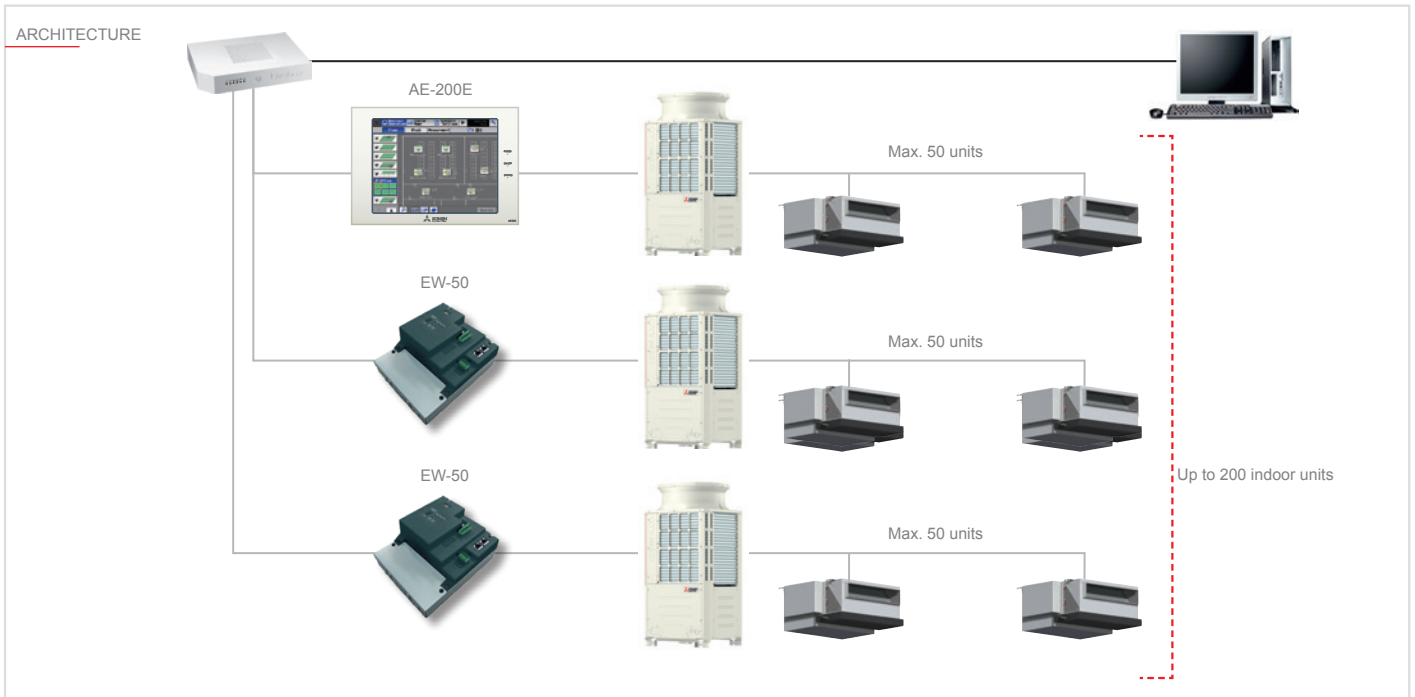

i If the AE-200 is not used, up to four EW-50 units may be connected.

Key Technologies

FUNCTION	DESCRIPTION	SETTING	DISPLAY
ON/OFF	Switch the units in the installation on or off.	○	○
Operating mode	Switches between the different operating modes available, which depend on the units installed: Cool./Dehumid./Auto/Vent./Heat.	○	○
Temperature setting	Used to modify temperature settings. The settable temperature range depends on the model of indoor unit installed.	○	○
Temperature increment setting	Temperatures may be set and displayed in steps of 0.5°C. *With certain combinations of units, temperatures are set and displayed in 1°C steps.	○	○
Fan speed setting	Settable fan speeds may be set to 4 levels, 3 levels, 2 levels or Auto. The settable fan speeds and modes (including Auto mode) depend on the model of indoor unit.	○	○
Air flow direction	Five fixed positions or auto-direction mode are selectable (settings and modes available depend on units).	○	○
Enable/disable local operations	The following remote control functions may be disabled from specific settings on the centralised controller: ON/OFF, select operating mode, set temperature, fan speed, air flow direction, reset filter indicator lamp.	○	○
Ambient temperature display	Displays air temperature at intake of indoor units.	-	○
Error	In the event of a error concerning a unit, the error code and the unit involved are displayed.	-	○
Programme	For programming daily/weekly/seasonal weekly/annual timer schedules. The following functions and modes are settable: ON/OFF, operating mode, temperature setting, disable remote control, air flow direction.	○	○
Energy management	Displays energy consumption or operating hours. Requires optional device.	-	○
Ventilation functions (alone)	Group management is only available for non interlocked Lossnay units. Group functions available include auto ventilation, heat exchange and normal ventilation.	○	○
Ventilation functions (interlocked)	Free Lossnay units and indoor units may be interlocked to operate together. In this case, the treated air volume may be managed but the ventilation mode cannot be selected.	○	○
External inputs	The following level or impulse signal inputs are available. Level signals: "Emergency shut-off" or "Collective ON/OFF" Impulse signals: "Collective ON/OFF" or "Enable/disable local remote control" • Requires PAC-YG10HA external input/output adapter (purchased separately). Only one input from those listed may be selected.	□	-
External Outputs	"ON/OFF" signal and "Error/Normal" signal. Requires PAC-YG10HA external input/output adapter (purchased separately).	-	□
Web browser	Usable to monitor/control: Errors, filter indicator lamp status, settable temperature range restrictions and other functions.	○*1	○*1
Filter reset	Reset filter indicator lamp	○	○
Consumption apportioning	The EW-50 controller is capable of calculating consumption values for separate users (requires PRO-3DCHARGE or RMI CHARGE consumption apportioning system).	●	-

○ Each group □ Each unit ● Each block ○ Collective

• Notes *1Certain elements do not support multi-group setting and display functions.

PIN Code licenses for Web Server centralised controllers

PIN Codes are purchasable licenses for enabling optional functions. See following table for details:

PIN Codes			
PIN CODE	FUNCTION	3D BLIND CONTROLLER EW-50	3D TOUCH CONTROLLER AE-200
PIN-WEB-PER-150	Personal Web	Optional	Optional
PIN-INT-150	Interlock programming	Optional	Optional

Personal WEB function

The Personal Web functions allows each user of the installation to control their respective air conditioning units individually from a browser installed on a PC. Unlike the standard Web Browser function, which is for managing all the units in the installation, the Personal Web function is configurable to define the units controllable from a browser for each individual user, prohibiting access to all other parts of the installation. This means that each user can only access their own air conditioning units. To use this function, users must be connected by PC to the same LAN network as the centralised controller. Up to 50 users may be defined, with up to 50 units assigned to each user. The functions available from the Personal Web function as the same as those of a conventional remote controller. Functions typically reserved for the administrator of the installation, such as timer functions and fault logs, are not accessible.

The new browser interface also permits control over the system from a tablet or smartphone, by connecting the relative device to the local LAN WiFi network. So in addition to the capabilities of the new interface, this means that users can be allowed access to all available control functions from any of today's most commonly used devices and from anywhere within the Wi-fi coverage zone, simply, immediately and without the need for any additional wiring.

Interlock programming

The interlock programming function may be used to define an interdependent operation relationship between two units in the system. Specifically, this function may be used to define the response of one unit (in terms of operating parameters) to a given event relative to the other unit.

For instance, one air conditioning unit may be programmed to switch on if another air conditioner stops due to a malfunction. Furthermore, interlocked functions may also be controlled from signals received from external systems such as safety systems, magnetic card readers, lighting system controllers etc. For example, the signal from a window open sensor may used to switch off the indoor unit in the relative room.

This makes it possible to manage a complex system efficiently and automatically, defining automated actions to not only improve comfort within the building, but to also respond rapidly in the event of a malfunction.



3D CHARGE

CONSUMPTION APPORTIONING SYSTEM FOR CENTRALISED CONTROLLERS



AE-200



EW-50

3D CHARGE consumption metering and apportioning system

The Charge consumption monitoring and apportioning system may be used to meter the consumption of electric power, thermal power and water for air conditioning, air and/or water heating and domestic hot water production with a Mitsubishi Electric VRF-HVRF CITY MULTI system, and calculate individual usage values.

The **AE-200** and **EW-50 CHARGE** systems use proprietary Mitsubishi Electric calculation and apportioning methods.

This consumption apportioning method indicates the consumption parameters of each user as percentages of the total consumption of the system. Consumption values, as percentages and kWh, may be calculated separately for:

- Outdoor Units
- Indoor Units
- Ecodan HWS Hydronic Modules
- Ecodan ATW Hydronic Modules

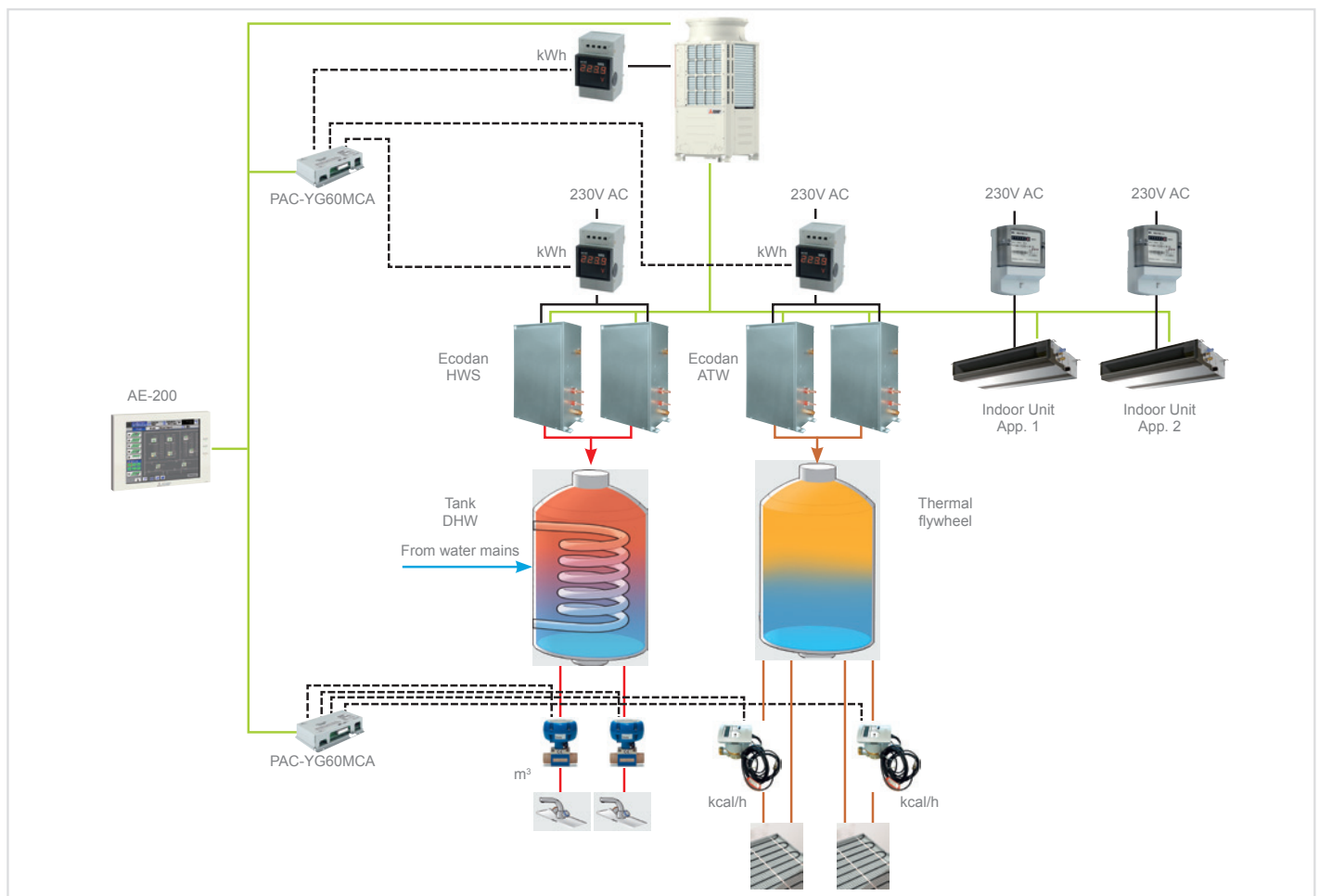

3D PLAN

INSTALLATION LAYOUT MAP DISPLAY SYSTEM FOR CENTRALISED CONTROLLERS



AE-200



EW-50

Installation layout map display system (3D PLAN)

Purchasing the respective Pin Code and activating this function makes it possible to display the plan view of the building on the touch screen of the **AE-200** centralised controller indicating the effective positions of all the indoor units in the installation. This makes the entire architecture of the installation simpler and more immediate to understand and manage, and is especially useful for very large and complex systems.

Purchasing this package enables the following functions:

- Display of installation layout maps defined for the specific installation
- Ability to load and configure installation layout maps
- Site user manual

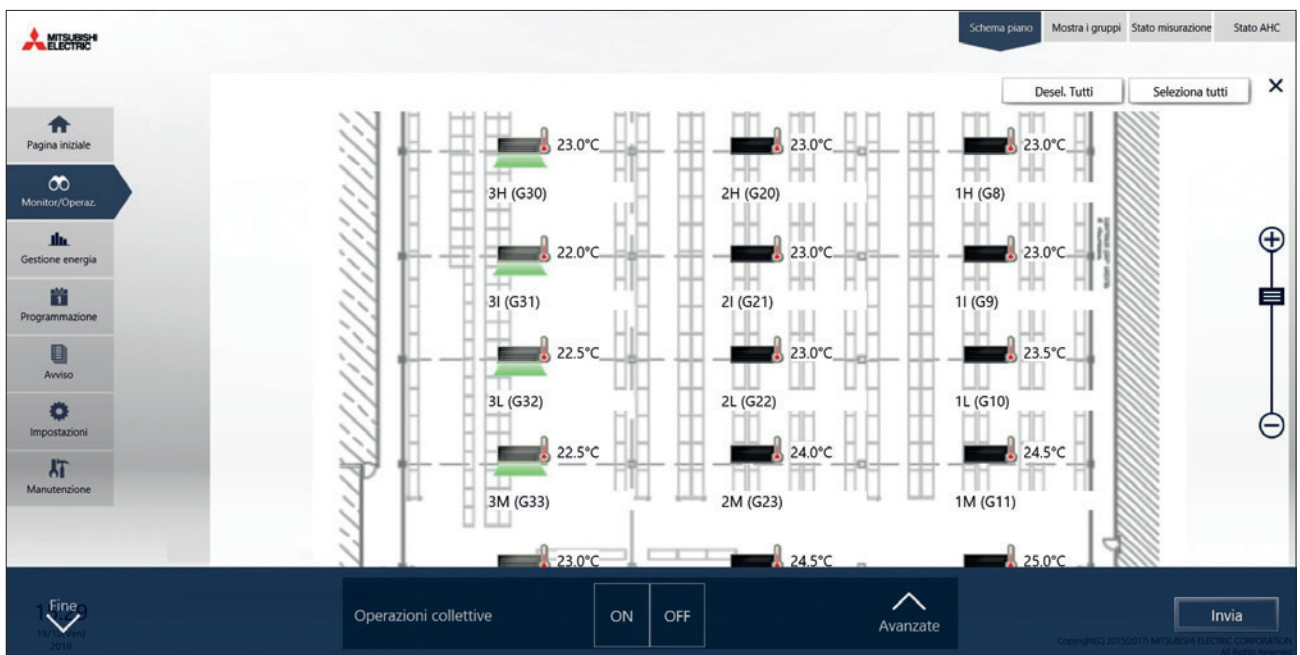



Remote management and supervisor systems for VRF and HVRF installations

CITY MULTI



3D Tablet Controller

The new 3D Tablet Controller remote control system permits the management and supervision of the installation from smartphones and tablets **within the building network**. The ability to configure different user profiles, with different access levels and user rights, makes this the ideal solution for centralised installations encompassing multiple independent zones, such as office buildings and condominiums. The simple and intuitive interface offers users **complete control**

over air conditioning and domestic hot water production units from mobile devices **within the building**, with the same functions as a conventional remote control. The ability to access these functions from anywhere within the building is made possible by a 3D WEB Server centralised controller connected to the Wi-Fi*1 router of the building.

*1 Not supplied by Mitsubishi Electric.

INSIDE THE BUILDING



 **MELCloud**[®] **MELCloud**
CITY MULTI



• Cloud based **remote management and supervisor system**.

- Conceived originally for residential applications, and now extended to include VRF-HVRF CITY MULTI systems.
- A complete **and intuitive solution**, with all the main control and monitoring functions for units.
- Does not require 3D WEB Server centralised controller (AE-200, EW-50).

 **RMI** **RMI**
REMOTE MONITORING INTERFACE

• Professional **cloud based remote management and supervisor system**.

- Allows all essential operations for managing air conditioning units to be carried out remotely.
- Includes a number of **advanced system energy consumption monitoring functions**, such as displaying hourly consumption, acquisition of numerous operating parameters and custom parameter graphs.
- Multi-installation **management** with geolocalised map display.
- Multi-user **management** for centralised installations.
- **Calculate and view** individual consumption for each user*³.

			
Simplified individual/collective control and management* ²	•	•	•
Available for smartphones and tablets	•	•	•
Dedicated app		•	•
Settable user restrictions	•	•	•
Available in 'outside building' mode (Cloud)		•	•
Internet connection needed		•	•
Requires WEB Server centralised controller	•		•
Advanced energy consumption monitoring			•
Monthly/custom graphs and reports			•
Multi-installation management			•
Consumption apportioning between individual tenants/users			•

*² See product catalogues or contact head office for information on compatible products.

OUTSIDE BUILDING



3D TABLET CONTROLLER

WI-FI MANAGEMENT SYSTEM



Discover the Wi-Fi management system by Mitsubishi Electric

The new 3D Tablet Controller function permits the management and supervision of the installation from smartphones and tablets **within the building network**.

Simple and intuitive to use

As it is accessed from any internet browser, the function is usable without installing a dedicated app. This means that the function is not restricted to specific platforms (iOS, Android, Windows Mobile), and is therefore not limited by the availability of dedicated apps on different app stores.

A simple and intuitive interface

The simple and intuitive interface offers users complete control over air conditioning and domestic hot water production units from mobile devices within the building, with the same functions as a conventional remote control.

The ability to access these functions from anywhere within the building is made possible by a WEB Server centralised controller (**AE-200** or **EW-50**) connected to a Wi-Fi router (not supplied by Mitsubishi Electric).

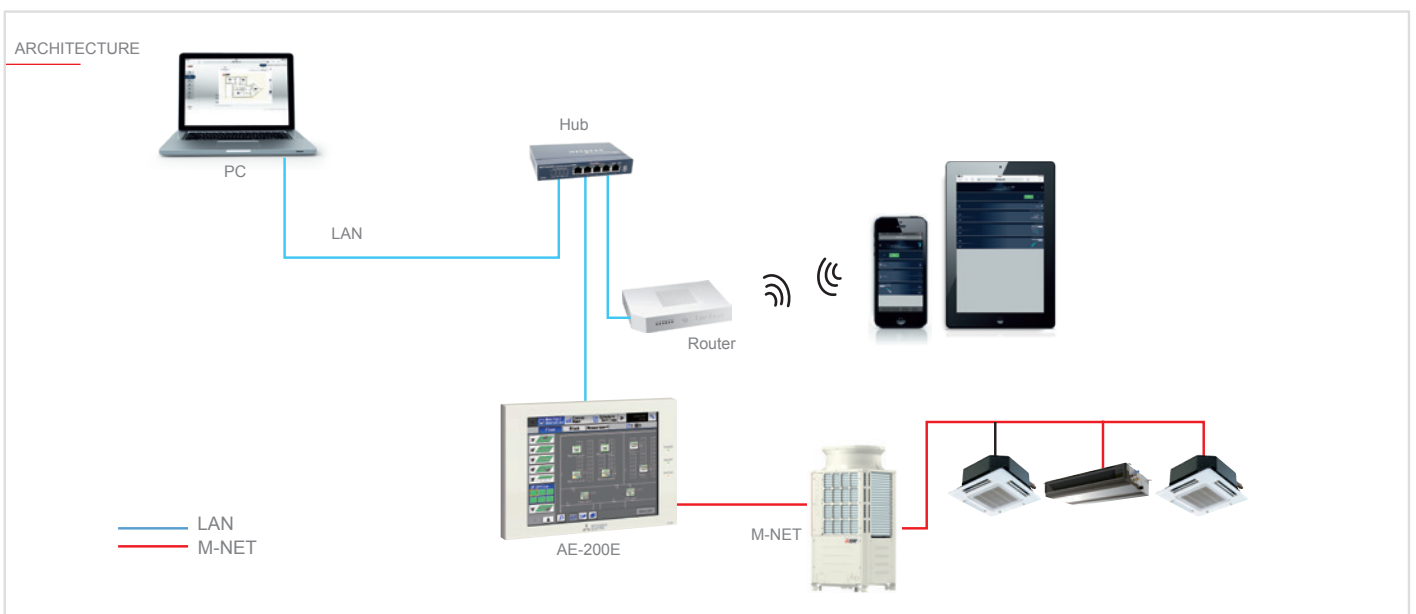



A mobile interface

The web interface features a design inspired by classic smartphone and tablet apps, for immediate and intuitive usage on a mobile device.

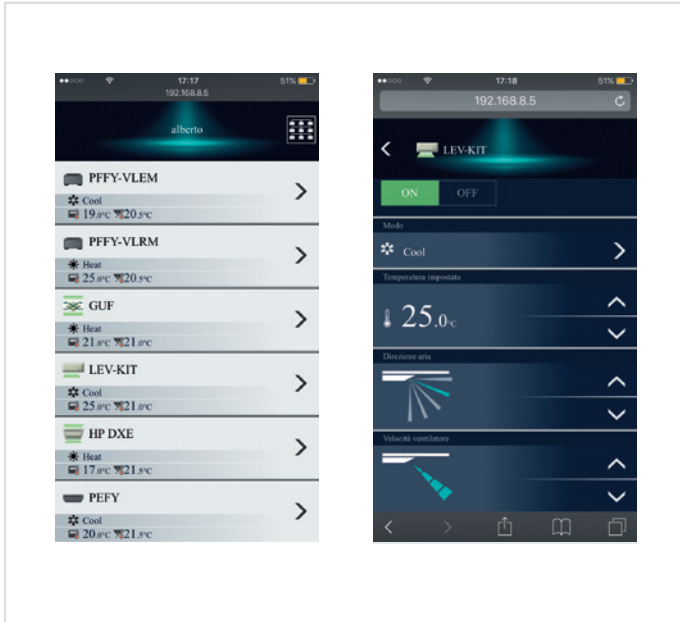

Advantages

- Compatible with all smartphone and tablet mobile devices, regardless of brand or operating system
- No internet connection needed, as the device and centralised controller communicate directly via the router
- Makes it no longer necessary to keep remote controllers in sight in the indoor spaces controlled
- Configurable user profiles, with different user rights and/or restricted access to available functions

MELCLOUD CITY MULTI

CLOUD-BASED REMOTE MANAGEMENT AND SUPERVISOR SYSTEM



MELCloud, the Wi-Fi controller for VRF-HVRF CITY MULTI systems

MELCloud, the new Wi-Fi controller for your Mitsubishi Electric VRF system. By using the cloud for sending and receiving information and the dedicated Wi-Fi interface (MAC-5871F-E), you can now control your VRF system easily wherever you are from any PC, tablet or smartphone with an internet connection.

The MELCloud service has been designed to ensure complete compatibility with PCs, tablets and smartphones via dedicated apps or via a web browser

Registering the system

The system must be registered to activate the MELCloud service. Once the interface is connected to the indoor unit and paired with the router, the system itself may be registered. To activate Wi-Fi control capability, simply access the website www.melcloud.com, sign up as a user and register the interface used. After registering, you will be able to take full advantage of the potential offered by the MELCloud service and manage your VRF system from any location over the internet.

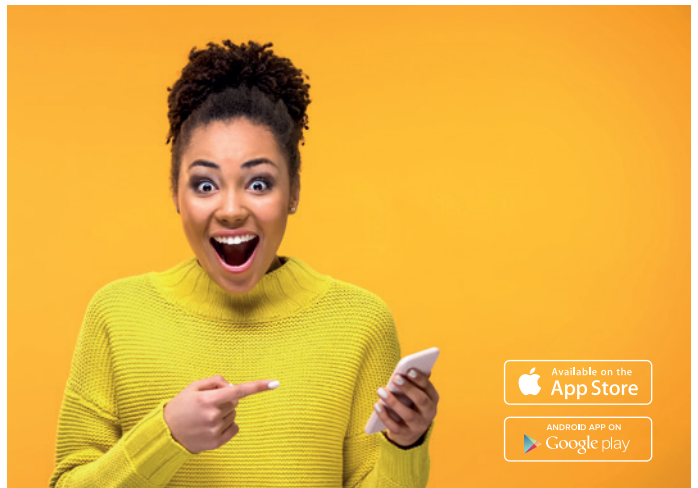

Control functions for CITY MULTI indoor units

Main functions:

- On / Off
 - Mode (Auto/Heat./Cool./Ventilation)
 - Fan speed
 - Programmable weekly timer
 - Louvre angle setting
 - View and set ambient temperature
 - Local weather information
- (availability of functions depends on the model of indoor unit connected to the controller)



Control functions for Lossnay ventilation systems

Main functions:

- On / Off
- Ventilation mode
- Fan speed
- Timer

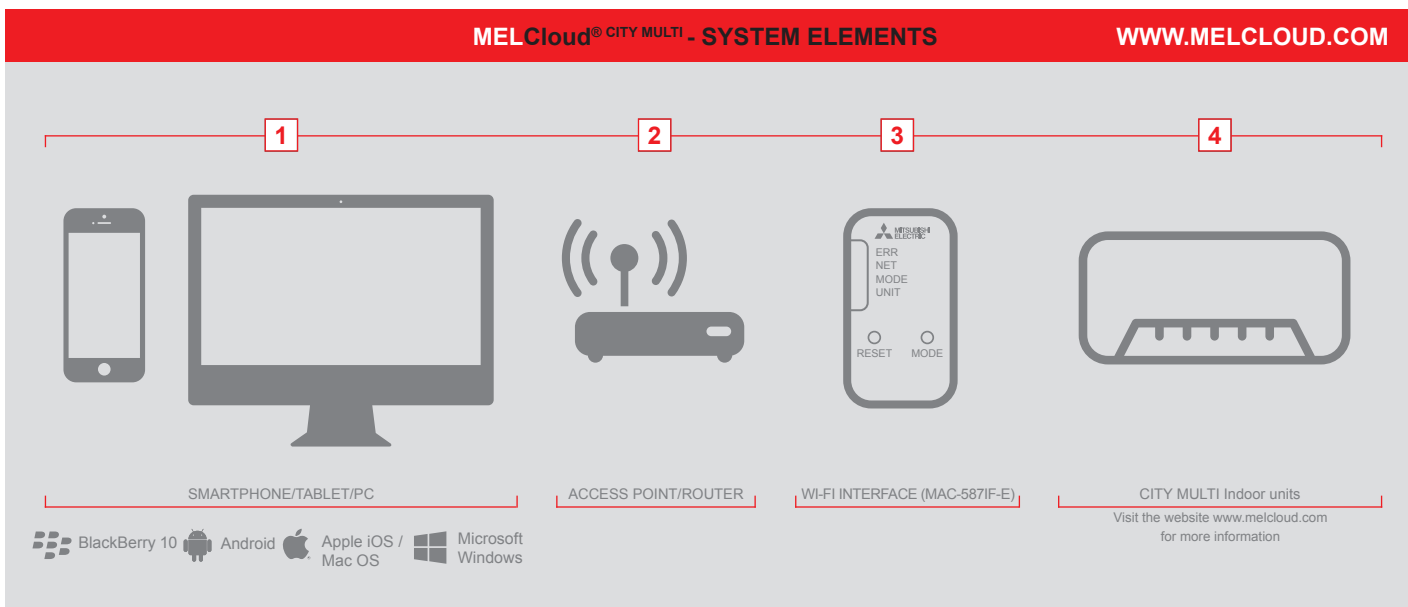
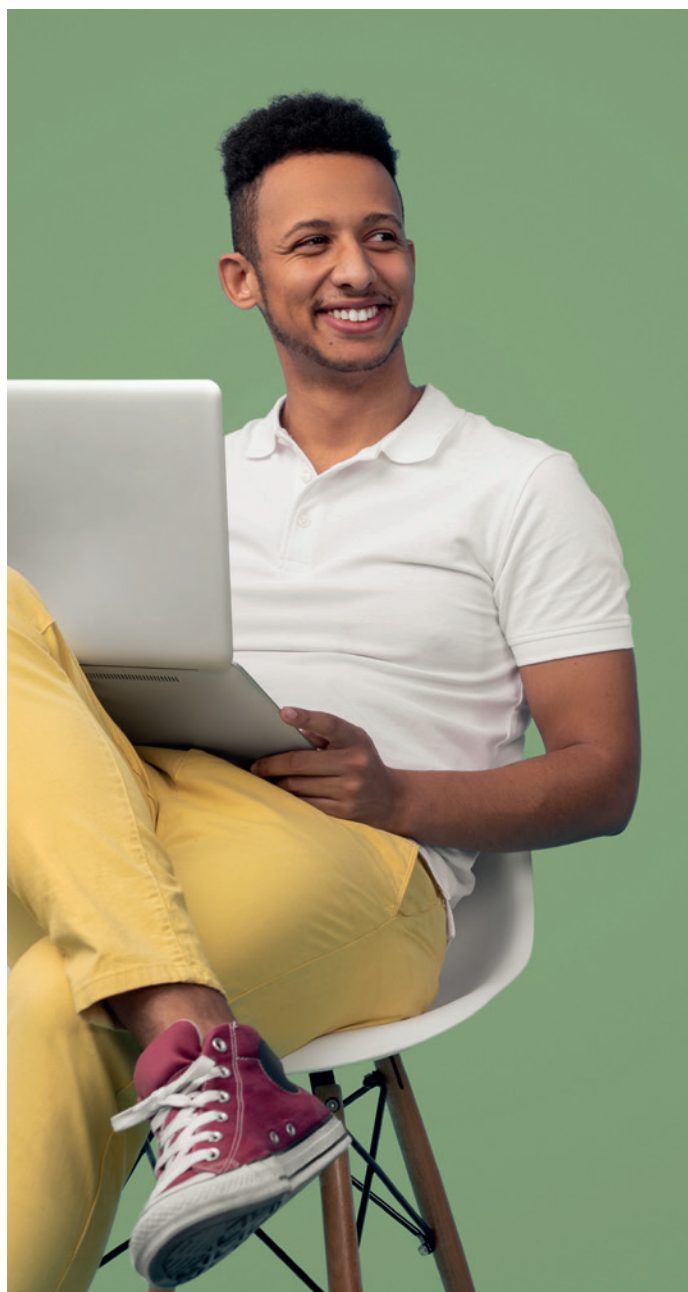

REMOTE MONITOR INTERFACE (RMI)

CLOUD-BASED REMOTE MANAGEMENT AND SUPERVISOR SYSTEM FOR PROFESSIONAL USE



Discover the Cloud system by Mitsubishi Electric for professional use

The RMI system lets you control your air conditioning, heating and domestic hot water production system remotely from a smartphone, tablet or PC. The system may be used to monitor the performance of your appliances, programme functions, check consumption and view operating states to optimise the efficiency of the system.

Your perfect climate in an App!

The Mitsubishi Electric RMI app, available for iOS and Android devices, lets users control their air conditioning systems, view and manage hot and cold water production parameters and check for malfunctions.

Control all your installations simply

Set weekly programmes and special events, and view and analyse the operating parameters of your system remotely from a mobile device with a graphic interface that lets you change settings instantaneously when needed.



ALL FROM AN APP ON YOUR SMARTPHONE OR TABLET.

- User interface with fresh, contemporary design
- Intuitive to use
- Select installation
- Block/floor view modes
- Collective control by block/floor
- Manage system functions
- Enable/disable user accessible functions
- View timer settings for group
- Energy consumption dashboard
- Energy consumption apportioning via app for each individual tenant

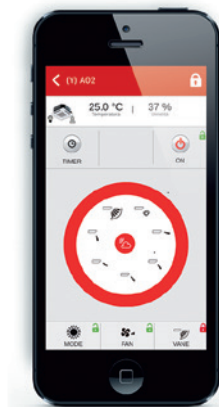

System architecture

The WEB Server (AE200, EW-50) centralised controller performs the crucial role of acquiring and monitoring data via the M-Net data transmission bus linking all the components of the VRF-HVRF CITY MULTI, Mr. Slim or Residential system. A router (available as wired ADSL or 3G Mobile versions) creates a secure, protected communication channel with the RMI Server. The modular flexibility of the RMI Server makes it possible

to store enormous volumes of data, which is acquired, processed and archived for access from portable devices. This infrastructural complexity, combined with superior processing, management and security capabilities, is encapsulated in an extremely user friendly concept, to help users optimise the energy usage of their systems.



Management and monitoring

RMI allows all essential operations for managing air conditioning units to be carried out remotely. Users can switch units on and off, change operating mode and set temperature, fan speed and air flow direction. These functions are available for individual units or groups of units of the same type.

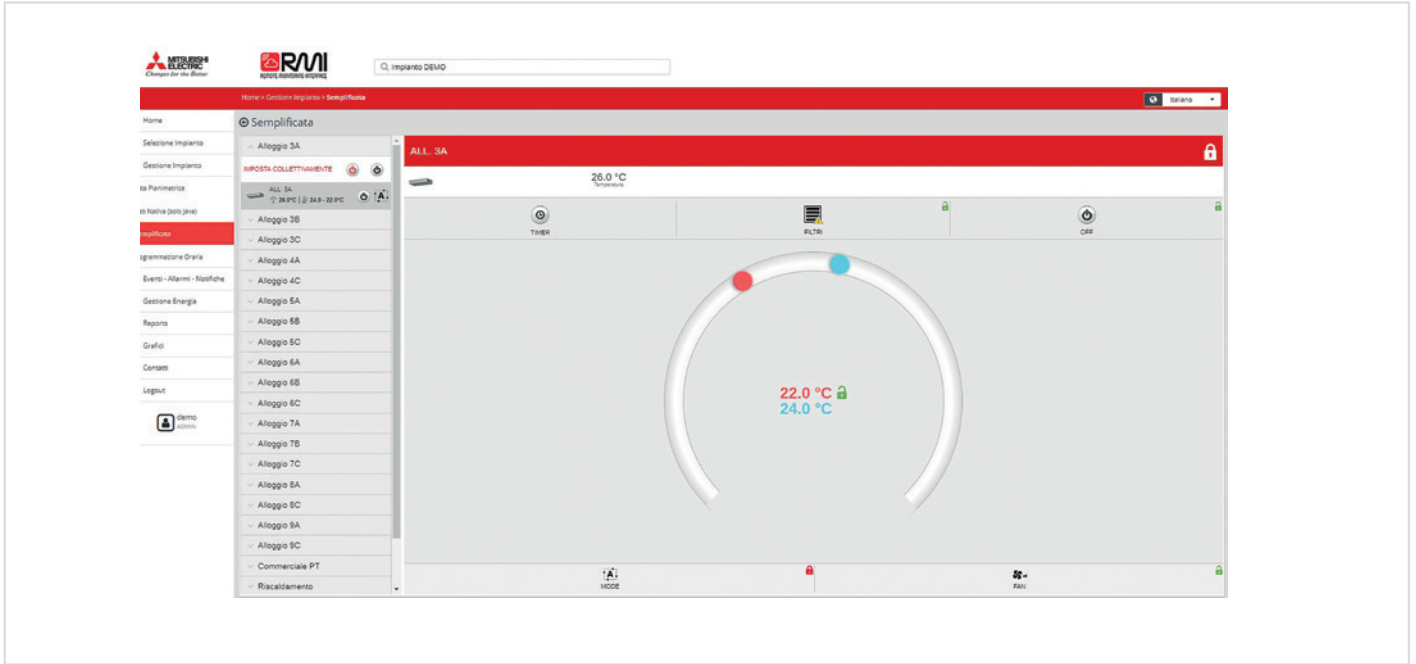

A number of system activity monitoring functions are also available, such as viewing hourly consumption. The main screen contains an intuitive and immediately comprehensible summary of the activities of the installation.

The user may view graphs relative to consumption and external temperature, with the average for the period also displayed for comparison. A summarised report indicating current power demand and active faults can also be displayed.

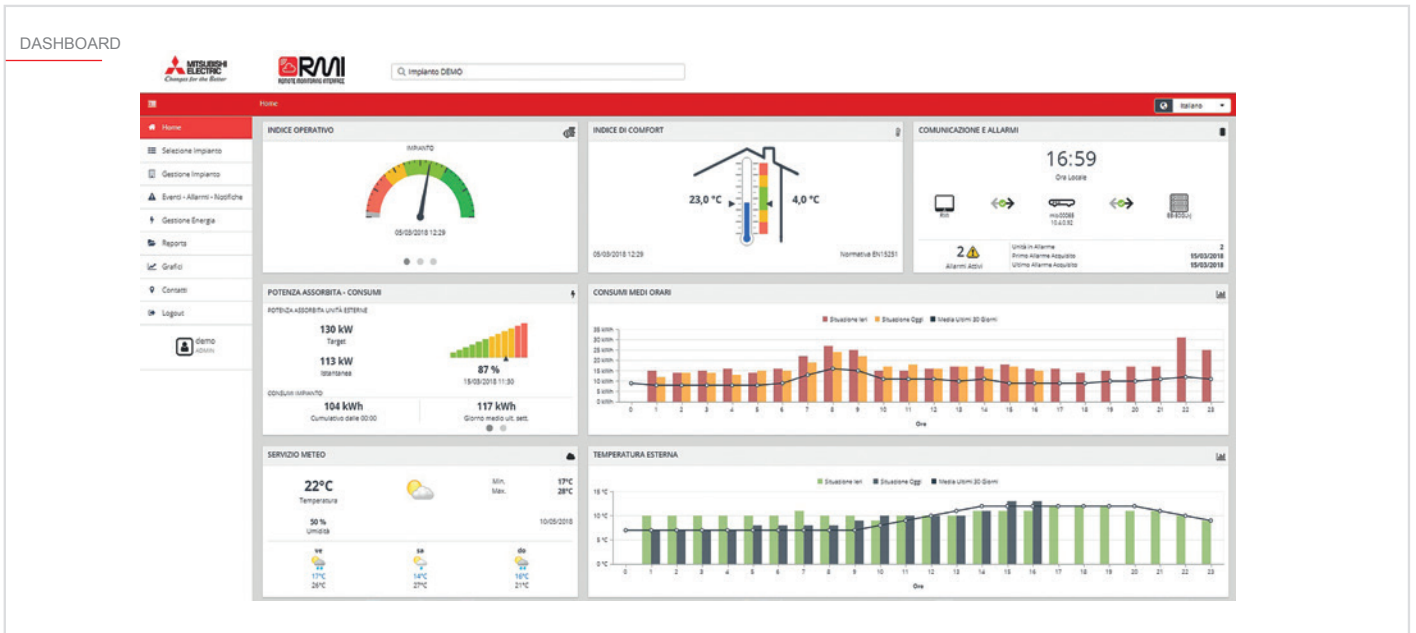

The user may browse the functions of the menu to access specific functions for managing individual units or groups of units, and view and set operating parameters as required.

A timer function is available for programming weekly schedules for the

installation. The time also includes options for setting an annual schedule and for defining special days throughout the year.

A timer schedule may be created from scratch from RMI and then either transmitted in cascade or exported to the centralised controllers in the installation.

TIMER PROGRAMMING

Events - Alarms - Notifications

RMI displays any system malfunction states in real time. The user may use the specific menu to view details of the event remotely, with information on the units involved and the time of the event. A log maintains a permanent

record of all past faults, and may be exported in Excel format for use by maintenance personnel.

EVENTS - ALARMS - NOTIFICATIONS

Segnalato #	Unità	Codice	Descrizione	Letture Evento Attiva	Letture Evento Ripristinato
	Centralizzatore (466.98)	9999	Connessione interrotta con impianto	21/08/2016 14:48:48	21/08/2016 18:50:37
	Centralizzatore (466.98)	9999	Connessione interrotta con impianto	21/08/2016 14:48:48	21/08/2016 18:50:37
	Centralizzatore (466.98)	9999	Connessione interrotta con impianto	28/08/2016 02:12:12	28/08/2016 02:31:49
	Centralizzatore (466.98)	9999	Connessione interrotta con impianto	28/08/2016 02:12:12	28/08/2016 02:31:49
	PROD. IRR. PAV (466.14)	2000	Anomalia sistema energia	13/10/2016 09:30:07	13/10/2016 10:28:07
	PROD. IRR. PAV (466.14)	2000	Anomalia sistema energia	13/10/2016 10:30:07	13/10/2016 11:28:15
	PROD. IRR. PAV (466.14)	2000	Anomalia sistema energia	13/10/2016 11:30:13	13/10/2016 12:28:08
	PROD. IRR. PAV (466.14)	2000	Anomalia sistema energia	13/10/2016 12:30:08	13/10/2016 13:28:09
	PROD. IRR. PAV (466.14)	2000	Anomalia sistema energia	13/10/2016 13:30:09	13/10/2016 14:28:10
	PROD. IRR. PAV (466.14)	2000	Anomalia sistema energia	13/10/2016 14:30:10	13/10/2016 15:28:10

Graphs

One of the great strengths of the RMI platform is its ability to create a wide variety of graphs for analysing the performance and functions of the air conditioning installation. A tool available on the website and in the app lets users view and compare system operating parameters in choice of different graph formats. In addition to standard and simple to read statistical graphs, users can also generate custom line and bar graphs of parameters selected manually from those offered by the platform for comparison. The user can also define the time period represented in a graph and filter by type of unit. This tool is helpful for any user who needs to keep the performance of the

installation under close scrutiny in order to reduce energy consumption, and is particularly useful as a support tool for system administrators, designers, installers and maintenance technicians, which lets them offer the end user a system with even better efficiency and performance.

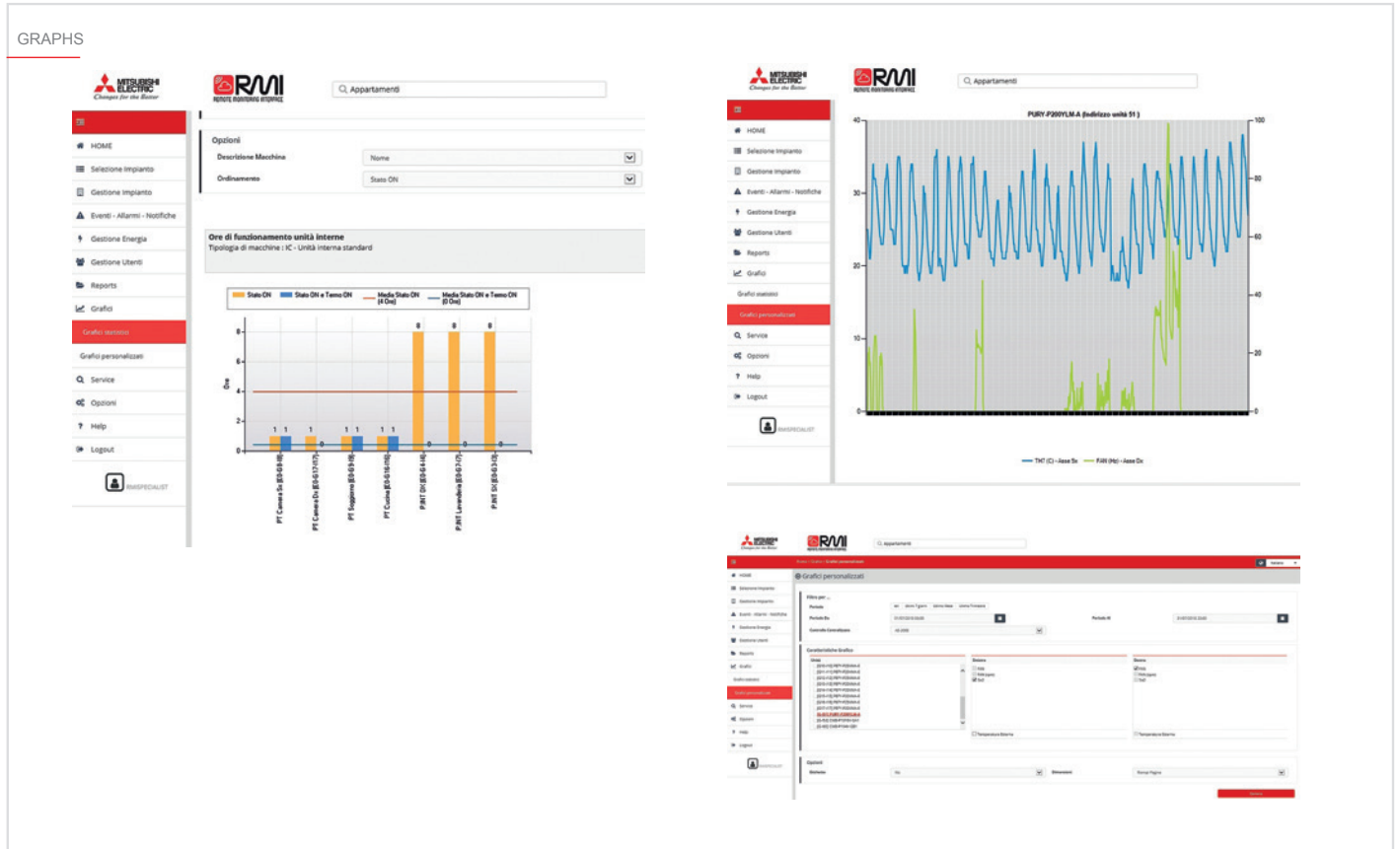

RMI Service packages

RMI can also be applied to an existing VRF-HVRF CITY MULTI system, by interfacing through the installation's existing WEB Server centralised controllers. Contact head office to check compatibility between hardware and available functions.

Find out more about the contracts available at the website: <http://rmiweb.mitsubishielectric.it/it/>

Discover the capabilities of RMI with the demo available at: <http://demo-it.rmi.cloud>

RMI IS AVAILABLE IN THE FOLLOWING PACKAGES

RMI SMART
REMOTE MONITORING INTERFACE

RMI ADVANCED
REMOTE MONITORING INTERFACE

RMI MULTI-TENANT
REMOTE MONITORING INTERFACE

RMI PLAN
REMOTE MONITORING INTERFACE

RMI CHARGE
REMOTE MONITORING INTERFACE

RMI SMART



The RMI SMART service/package, offered under license with an annual subscription fee, lets users manage air conditioning, heating and domestic hot water production systems:

- from Android or iOS smartphone and tablet mobile devices;
- via internet and/or over a local network, from the Web Client reserved area.

Users may download an app for the aforementioned iOS and Android devices free of charge from the respective on-line app stores. The RMI SMART service/package is compatible with WEB Server G-50, GB-50, GB-50ADA, AG-150A and EB-50GU centralised controllers, and later controller models. This means that it can also be used with existing VRF-HVRF CITY MULTI systems that have already been in operation for some time.

When interfacing with an installation with a G-50, GB-50, GB-50ADA or AG-150A WEB Server centralised controller, it will not be possible to upgrade to the RMI ADVANCED package unless the existing WEB Server controller is replaced with a WEB Server AE-200 or EW-50 centralised controller (or later version) with a valid RMI PIN Code license.

Available functions

The RMI SMART service/package enables the following functions:

- manage ONE installation at a time (SINGLE INSTALLATION);
- manage installations remotely and in real time from the app;
- manage and control installations via the CLASSIC WEB interface (from WEB Client reserved area only);
- view active faults displayed in pop-up screens;
- configure 2 weekly timers for automatic seasonal changes;
- configure 1 annual timer for automatic management of special events;
- display geolocalised weather information.

RMI ADVANCED



The RMI ADVANCED service/package, offered under license with an annual subscription fee, lets users manage air conditioning, heating and domestic hot water production systems:

- from Android or iOS smartphone and tablet mobile devices;
- via internet and/or over a local network, from the Web Client reserved area.

Users may download an app for the aforementioned iOS and Android devices free of charge from the respective on-line app stores. Users may access the remote management system included in the RMI ADVANCED service/package by simply connecting a WEB Server AE-200, EW-50 or centralised controller (o later models) which must be activated previously with the RMI PIN Code license to enable the function, to the internet.

Available functions

The RMI ADVANCED service/package enables the following functions:

- manage multiple installations with the same access credentials (MULTI-INSTALLATION);
- view a geolocalised map display of the installations (from WEB Client reserved area only);
- manage installations remotely and in real time from the app;
- manage and control installations via the CLASSIC WEB interface (from WEB Client reserved area only);
- view active faults displayed in pop-up screens;
- view fault log;
- configure 2 weekly timers for automatic seasonal changes;
- configure 1 annual timer for automatic management of special events;
- email and SMS fault notification messaging;
- view and download monthly functional/administrative graphs;
- generate, view and download monthly functional/administrative reports.

RMI MULTI-TENANT



The RMI MULTI-TENANT service/package, offered under license with an annual subscription fee, is an upgrade for the RMI-SMART and RMI-ADVANCED services/packages which enables MULTI-USER management. Specifically, this upgrade enables Master functions, allowing a system administrator to create and manage a number of sub-users (individual tenants) limited only by the number of terminal units installed, and assign sections of the installation and specific functions selectively to each.

Once the RMI MULTI-TENANT service/package is activated, access is enabled to the Reserved Area of the WEB Client, and the function "User Management", which is disabled without the upgrade, is visible among the functions available for the selected RMI package (RMI SMART or RMI ADVANCED). The functionality for defining sub-users is not available in the app for smartphones and tablets.

Available functions

The RMI MULTI-TENANT service/package enables the following functions:

- User Profile: set user name and password for exclusive access;
- User identification details;
- Contact details;
- Functions assigned to user, allocated with the following parameters and information:
 - Default site definition;
 - Date of expiry of access rights, which may not be after date of expiry for MASTER user;
 - List of permitted functions for user profile, selectable by MASTER user;
 - Portion of installation assigned to (and visible to) user.

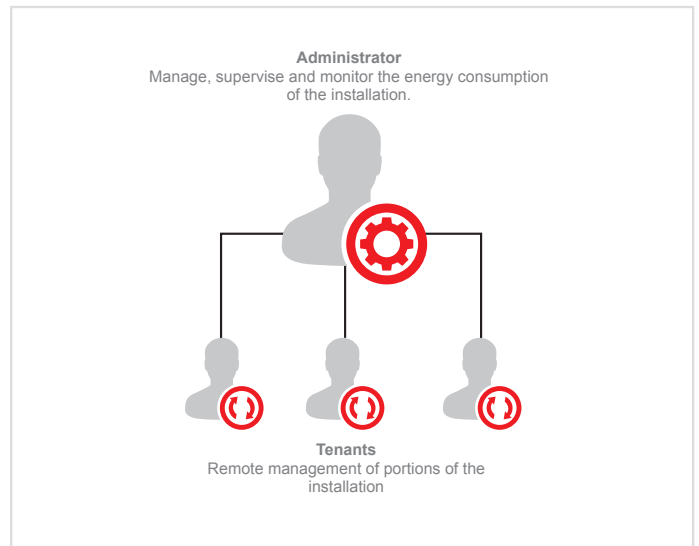

RMI PACKAGES AND FUNCTIONS	
PACKAGE	COMPATIBLE CENTRALISED CONTROLLERS
	G-50 GB-50 GB-50ADA AG-150 EB-50U EW-50 AE-200
	EW-50 AE-200
	G-50 GB-50 GB-50ADA AG-150 EB-50U EW-50 AE-200

RMI PLAN



RMI PLAN lets users load, position and configure a number of zoomable installation layout map views. The icons representing indoor units are interactive. Clicking any of these icons lets the user modify the operating status and parameters of the unit (ON/OFF, setpoint, mode, fan speed etc.). This makes the entire architecture of the installation simpler and more immediate to understand and manage, and is especially useful for very large and complex systems.

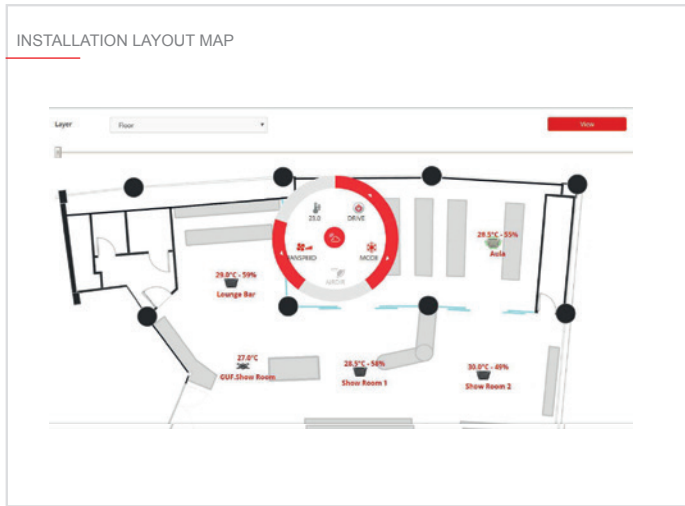

which are used to process the data acquired and calculate consumption. In addition to the consumption of the indoor units making up the individual energy blocks, the software also considers the influence of the indoor units on the energy consumption of the respective outdoor units. The consumption calculated for each user includes the consumption of the respective indoor units and the applicable proportion of the energy consumption of the relative outdoor unit, calculated in consideration of several factors such as operating temperatures (settings and measured values), LEV electronic valve aperture, electrical characteristics and unit operating times.

The RMI CHARGE cloud based consumption monitoring and apportioning system is compatible with:

- VRF / HVRF CITY MULTI systems;
- COMMERCIAL line products, if connected to WEB Server 3D centralised controllers via specific interfaces;
- RESIDENTIAL line products, if connected to WEB Server 3D centralised controllers via specific interfaces;

Characteristics

- Cloud based solution. Reliable and always available;
- DOES NOT need space for additional installation components or a dedicated PC;
- Installable and configurable remotely;
- Ensures extraordinary flexibility for the simultaneous monitoring and management of multiple installations from a single point;
- Automatically generated ready-to-use monthly reports for each energy block;
- Filter functions (yesterday/last 7 days/last month/last quarter/user-defined) for viewing and exporting energy consumption apportioning data
- Energy consumption may be apportioned automatically or with manually entered data;
- Consumption calculated as percentage of total to three decimal places;
- Data storage: 1 year.

RMI CHARGE



Energy consumption monitoring and apportioning system

Available as RMI CHARGE and RMI CHARGE+PLAN variants, the RMI cloud-based energy consumption monitoring and apportioning system is based on the proprietary Mitsubishi Electric calculation and apportioning method. All the elements in the installation may be grouped in "energy blocks" during the configuration of the supervisor system. The consumption monitoring and apportioning system continuously analyses the operating parameters of the elements in the installation, acquiring and processing data from the installation to produce energy consumption tables for the different users. Each element in the system is associated with its electrical characteristics,

In order to use the RMI CHARGE cloud based consumption monitoring and apportioning system, the centralised controllers, meter acquisition interfaces and the RMI Box (router) in the installation must be connected to each other over a LAN Ethernet network, and the RMI Box must be connected to the internet, either by a cable or Wi-Fi link to the data line of the client, or via a mobile data network (with a 3G SIM card enabled for data). RMI CHARGE can automatically acquire readings via PI (Pulse Input) interfaces from appropriately installed, connected and configured meters for electrical power (kWh), volume (m3) or thermal energy (kJ or thermal kWh) consumption.

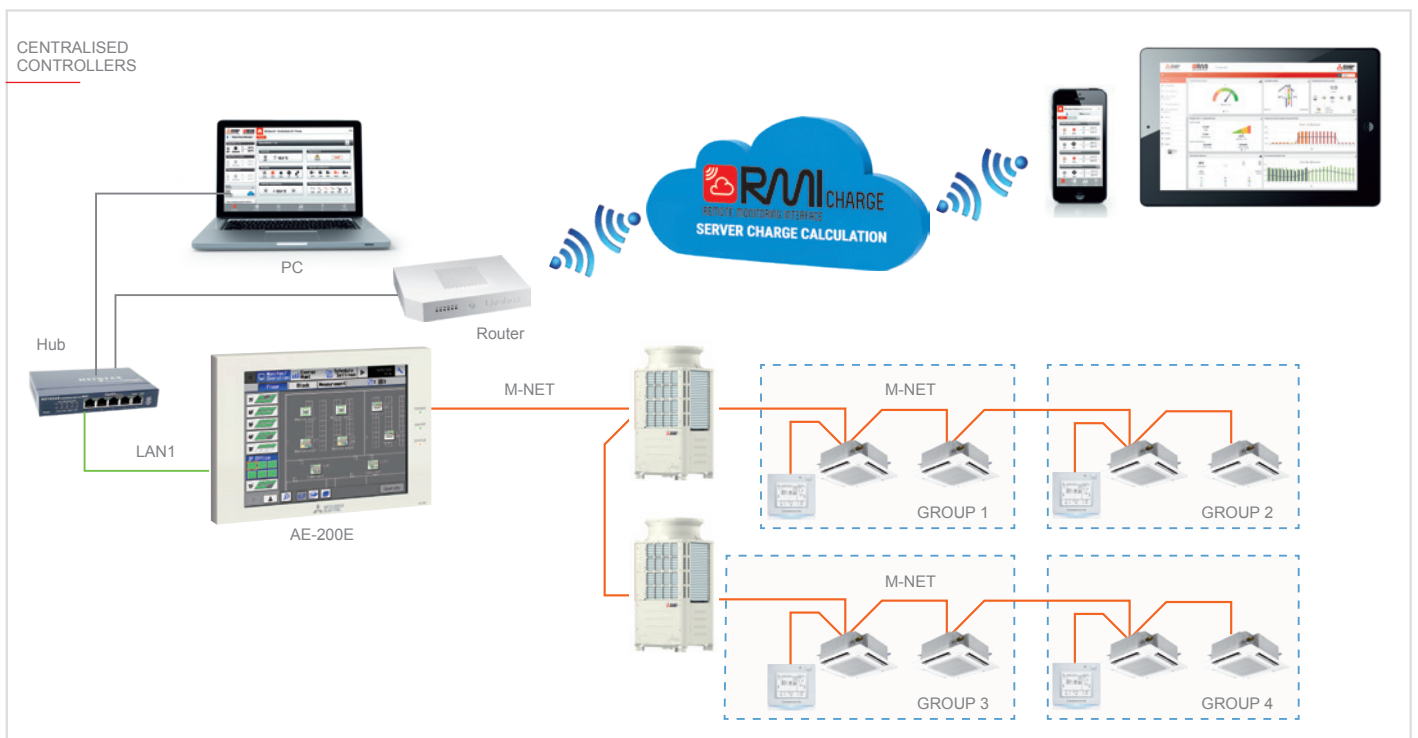

The RMI CHARGE cloud based system is capable of acquiring, calculating and apportioning consumption of the following energy utilities:

- Air heating/cooling
- DHW (domestic hot water) production
- Water heating/cooling

In the case of DHW production and water heating/cooling, the RMI system may also be interfaced with and monitor the production of third party generators (e.g. Ecodan, heat pumps, chillers etc.).

RMI CHARGE automatically generates read-to-use monthly reports. Energy consumption data may be viewed and exported in three modes, with the percentage energy consumption of each energy block relative to total energy consumption available in all three modes:

- Electrical consumption (total and for each energy block) in kWh (for all utilities monitorable with RMI CHARGE);
- Domestic hot water consumption (total and for each energy block) in cubic metres;
- Water consumption for cooling/heating (total and for each energy block), in thermal energy units (kJ or thermal kWh).

Filter functions (yesterday/last 7 days/last month/last quarter/user-defined) for viewing and exporting energy consumption apportioning data.

Apportioning of domestic hot water (DHS) consumption and/or consumption of water for heating/cooling

To permit apportioning, a meter must be installed for each individual user billable for separate energy utility usage.

If consumption is not acquired automatically from water volume meters and/or thermal energy meters connected to the system, the water and thermal energy consumption values for the outdoor units must be entered manually by the user in the RMI Cloud system to permit consumption apportioning.

If water volume meters and/or thermal energy meters are connected to the system via PI interfaces, the water and thermal energy consumption values for the outdoor units will be acquired automatically by the RMI Cloud system on a daily basis and used to calculate consumption apportioning.

Energy consumption apportioning in kWh

This consumption apportioning method indicates the consumption of each user in kWh.

Energy consumption apportioning in kWh is available for the outdoor units of the installation and, where all indoor units share the same power line, also for indoor units.

If electric power consumption is not acquired automatically from electric power meters connected to the system, the electric power consumption values for the outdoor units must be entered manually by the user in the RMI Cloud system to permit consumption apportioning.

If electric power meters are connected to the system via PI interfaces, the electric power consumption values for the outdoor units will be acquired automatically by the RMI Cloud system on a daily basis and used to calculate consumption apportioning.

CONSUMPTION APPORTIONING

Blocco	Totale		RISC-RAFFR. ARIA		RISC-RAFFR. ACQUA		PRODUZIONE ACS	
	kWh	%	kWh	%	kWh	%	kWh	%
App.09 0A	628.02	18.1	1.99	1.48	0	0	628.03	21.04
App.09 0B	648.82	18.62	1.24	0.92	601.96	47.88	147.03	4.96
App.09 0C	289.76	7.09	1.6	1.19	0	0	282.16	9.05
App.09 0A	671.23	16.19	2.48	1.88	0	0	668.78	22.86
App.09 0C	1.24	0.03	1.24	0.92	0	0	0	0
App.09 0A	127.82	3.09	0.87	0.73	0	0	126.94	4.28
App.09 0B	219.05	5.14	1.24	0.92	0	0	211.81	7.14
App.09 0C	141.8	3.42	1.24	0.92	0	0	140.56	4.74
App.09 0A	282.29	6.09	0.89	0.74	76.9	7.88	174.4	5.83
Ufficio P1	516.79	12.44	105.62	78.67	0	0	410.17	13.54
Ufficio P2	492.8	15.74	15.63	11.64	467.91	44.72	189.26	6.7
Totale	4.143.32	100%	134.24	100%	1.646.37	100%	2.864.71	100%
Ripartizione per servizio energetico	4.143.32	100%	134.24	3.24%	1.646.37	25.24%	2.864.71	71.52%



External signal integration



M-NET-AHC-24VDC

PROGRAMMABLE AHC CONTROLLER



AHC – Advanced HVAC controller

- Solution consists of an ALPHA2 PLC and an M-Net interface, both by Mitsubishi Electric.
- Intuitive object-based graphic programming function.
- Create control strategies using either physical signals (inputs and outputs) or logical signals (via M-Net data transmission bus).
- Receive signals from 2 Groups for a total of up to 32 indoor units for each PLC.
- Programme synchronised energy saving strategies between power consuming utilities (such as lighting) and the air conditioning system.
- 15 inputs and 9 outputs.
- The number of physical inputs and outputs may be increased with dedicated expansion modules.
- Large backlit LCD display for programming functions and viewing graphics, text and values.
- Direct programming with 8 function keys on front control panel without using auxiliary devices.
- Superior installation flexibility with integrated DIN rail adapter.
- System may be password-protected.

Total integration

The AHC programmable controller uses Mitsubishi Electric know-how acquired in industrial automation applications to integrate air conditioning, heating and domestic hot water production systems with third party systems, such as access control, security, lighting control systems etc., allowing communication between the systems via the M-Net data communication bus.

This makes it possible, for example, to use data acquired via the M-Net communication bus to control external devices instead of interlocking the operation of air conditioner units and external systems connected to the AHC Programmable Controller, or using other similar measures.

Flexible programming

Up to 200 function blocks can be used in a single application (Set/Reset, Timer, Service messages etc.), offering extraordinary scope for controlling the entire installation.

Secure programming

The application is stored permanently in an EEPROM memory module. This means that active data (such as meter counts) are backed up without requiring power.

Extensive operating temperature range

Designed to operate in a temperature range from 25°C to 55°C and with an IP20 protection rating, these devices are ideal for both indoor and outdoor installation.

Digital and analogue expansion modules

Dedicated expansion modules offer the possibility of increasing the number of both analogue and digital inputs and outputs.

Digital

AL2-4EX:

offers 4 digital inputs

AL2-4EYT:

offers 4 digital outputs

Analogue

AL2-2PT-ADP:

offers 2 analogue inputs

AL2-2DA:

offers 2 analogue outputs

PAC-YG60MCA

M-NET INTERFACE FOR DIGITAL IMPULSE CONSUMPTION METERS



M-NET Interfaces

M-Net interfaces were developed to permit the connection of a wide variety of input and output signals (i.e. for monitoring and control) to the MELANS management and supervision system. These interfaces are connected directly to the M-Net data transmission bus. The modular concept of these interfaces means that multiple interfaces can be connected to the same network. To connect interfaces, a 24V DC auxiliary power feed must be provided with an additional power supply unit (purchased separately). The following M-Net interfaces are available:

- PAC-YG60MCA: Digital meter interface (Pulse Input).
- PAC-YG63MCA: Analogue sensor interface (Analogue Input).
- PAC-YG66DCA: Digital sensor interface (DIDO).

PAC-YG60MCA – Pulse Input

The PAC-YG60MCA M-Net interface is a device for acquiring the output signals from wall or electrical cabinet mounted digital impulse consumption meters. This interface makes it possible to monitor the consumption of the installation with any electric power (WHM), water, and gas consumption meters and calorimeters producing an impulse type output signal. Up to 4 digital meters may be connected to each individual interface.

In order to use the interface, a WEB Server 3D (TOUCH or BLIND) centralised controller must be included in the installation to monitor the status of the system and enable the following functions:

- View real time consumption values
- View consumption graphs
- Export consumption billing data in CSV format for consumption apportioning (CHARGE).

Technical specifications

MODEL	DIMENSIONS (L X H X W)	WEIGHT	ELECTRIC POWER	M-NET CONNECTION	No. OF CONNECTIBLE INPUTS
PAC-YG60MCA	200 x 120 X 45	0.6 kg	24V DC, provided locally with auxiliary power supply	1.5 mm ² shielded	4

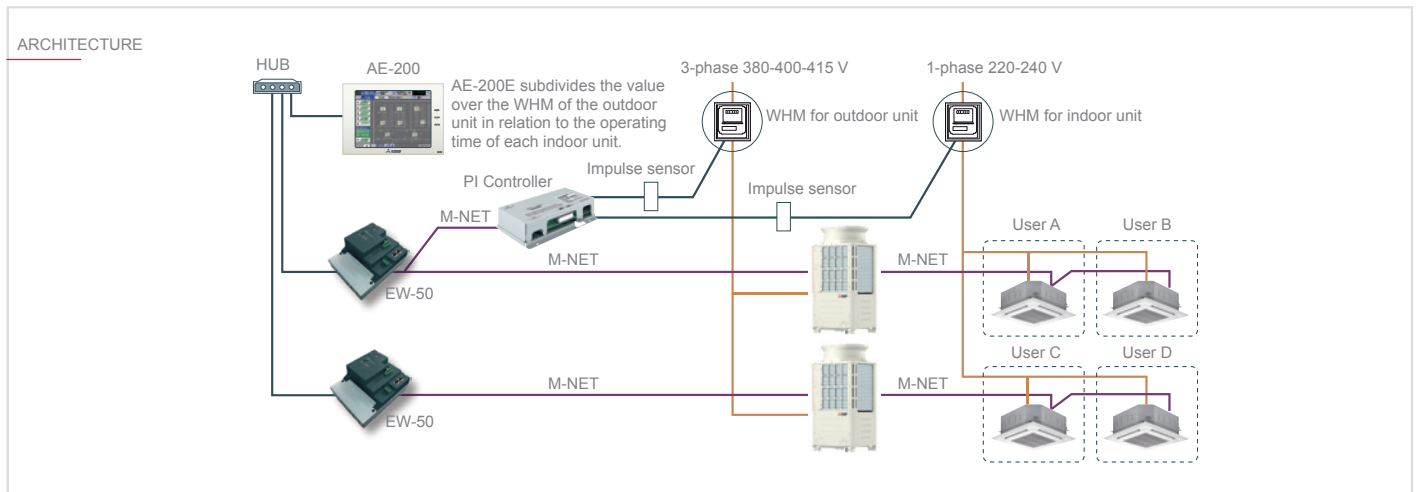

PAC-YG63MCA

M-NET INTERFACE FOR ANALOGUE SENSORS



M-NET Interfaces

M-Net interfaces were developed to permit the connection of a wide variety of input and output signals (i.e. for monitoring and control) to the MELANS management and supervision system. These interfaces are connected directly to the M-Net data transmission bus. The modular concept of these interfaces means that multiple interfaces can be connected to the same network. To connect interfaces, a 24V DC auxiliary power feed must be provided with an additional power supply unit (purchased separately). The following M-Net interfaces are available:

- PAC-YG60MCA: Digital meter interface (Pulse Input).
- PAC-YG63MCA: Analogue sensor interface (Analogue Input).
- PAC-YG66DCA: Digital sensor interface (DIDO).

PAC-YG63MCA – Analogue Input

The PAC-YG60MCA M-Net interface is a device for acquiring the output signals from wall or electrical cabinet mounted analogue temperature or humidity sensors. This interface makes it possible to acquire measurements from active analogue temperature and humidity sensors. A WEB Server 3D (TOUCH or BLIND) centralised controller is required to use the interface.

The following functions are available via a web browser:

- View real time sensor readings
- View graphs of sensor readings
- Export data in CSV format
- View alarm thresholds for e-mail notification function
- Alarm output to relay (on board interface) for cut-off if alarm thresholds are exceeded
- Interlock with air conditioner operation and with other input/output interfaces if alarm thresholds are exceeded
- View units as icons on installation layout maps

Technical specifications

MODEL	DIMENSIONS (L X H X W)	WEIGHT	ELECTRIC POWER	M-NET CONNECTION	No. OF CONNECTIBLE INPUTS
PAC-YG60MCA	200 x 120 X 45	0.6 kg	24V DC, provided locally with auxiliary power supply	1.5 mm ² shielded	2

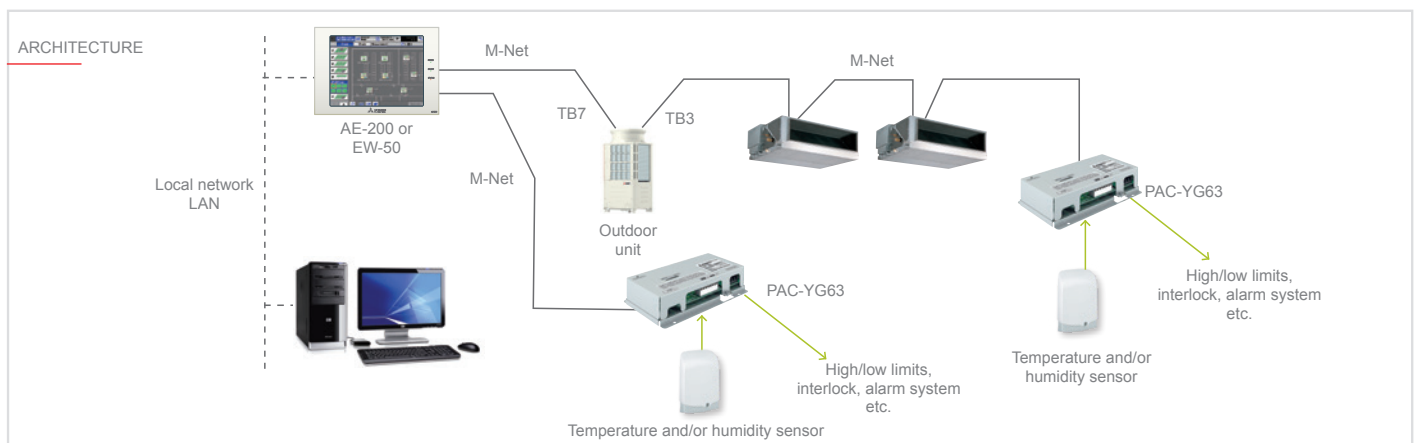

PAC-YG66MCA

M-NET INTERFACE FOR DIGITAL SENSORS



M-NET Interfaces

M-Net interfaces were developed to permit the connection of a wide variety of input and output signals (i.e. for monitoring and control) to the MELANS management and supervision system. These interfaces are connected directly to the M-Net data transmission bus. The modular concept of these interfaces means that multiple interfaces can be connected to the same network. To connect interfaces, a 24V DC auxiliary power feed must be provided with an additional power supply unit (purchased separately). The following M-Net interfaces are available:

- PAC-YG60MCA: Digital meter interface (Pulse Input).
- PAC-YG63MCA: Analogue sensor interface (Analogue Input).
- PAC-YG66DCA: Digital sensor interface (DIDO).

PAC-YG66MCA – DIDO

The PAC-YG60MCA M-Net interface is a device for acquiring signals from wall or electrical cabinet mounted digital input/output sensors. The interface is connected directly to the M-Net network (TB3-TB7), and occupies the same address as the indoor units (from 01-50) for each of the external devices connected (up to 6 external device).

Each external device may have the following inputs and outputs:

- 1 ON/OFF command signal output
- 1 ON/OFF status input
- 1 malfunction status input

A WEB Server 3D (TOUCH or BLIND) centralised controller and, if required, a supervisor system, are needed to use the interface. The following functions are available:

- View state of ON/OFF or malfunction status inputs
- Control ON/OFF output
- Interlock with air conditioner functions
- Interlock with other digital inputs/outputs (even relative to other interfaces)
- View units as icons on installation layout map

The interface also includes a relay and terminal boards integrated on the electronic board of the interface itself for connecting two external devices. Two additional PAC-YG10HA accessory modules must be installed to permit connection of the remaining four external devices to the interface. These accessory modules enable additional open collector output signals. The relative connector terminal boards and control relays, however, must be obtained and installed separately.

Technical specifications

MODEL	DIMENSIONS (L X H X W)	WEIGHT	ELECTRIC POWER	M-NET CONNECTION	No. OF CONNECTIBLE INPUTS
PAC-YG66MCA	200 x 120 x 45	0.6 kg	24V DC, provided locally with auxiliary power supply	1.5 mm ² shielded	2+4

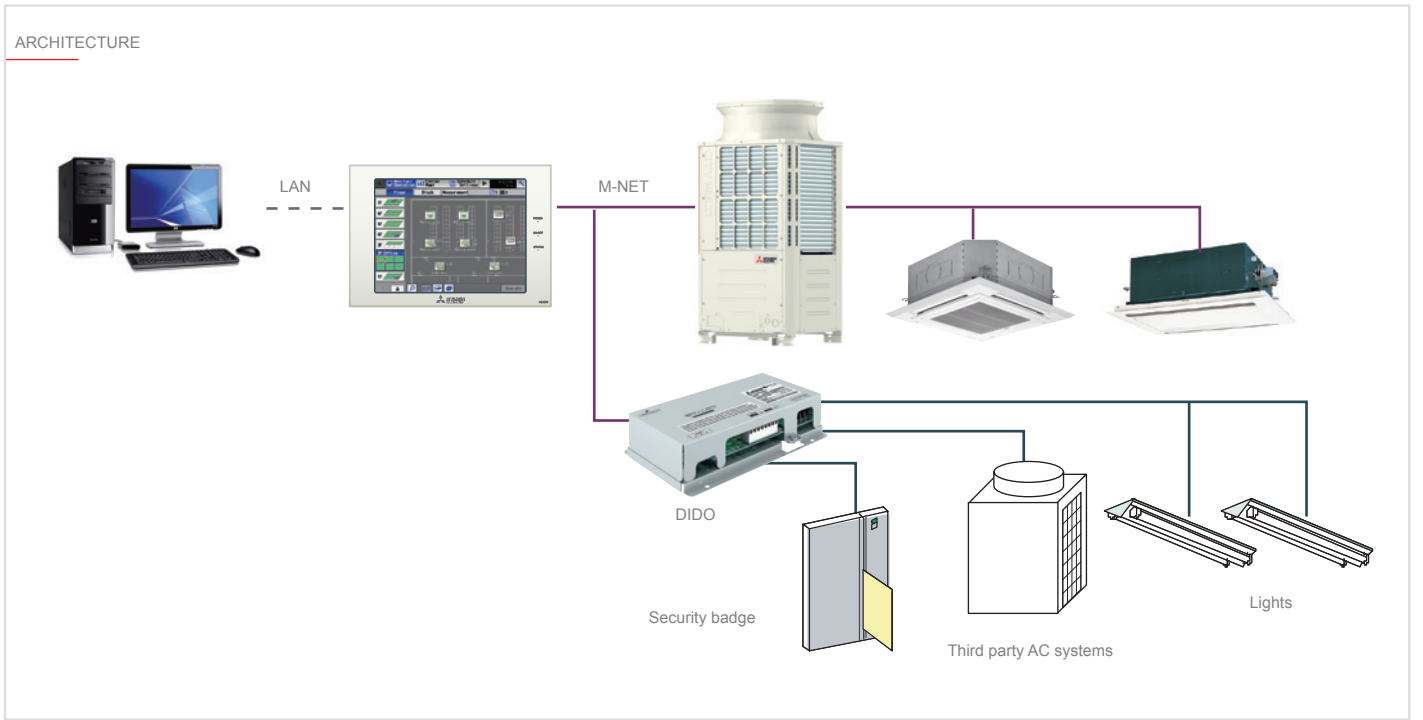

Smart terminal blocks

Smart Terminal Blocks

Smart indoor unit terminal blocks are a unique feature of Mitsubishi Electric VRF systems. These intelligent terminal blocks make it possible to use the air conditioning system and the M-NET communication network, via the indoor units, as a vehicle for collecting, transferring and monitoring field signals from generic appliances such as lighting, power, access management and intelligent alarm systems, pumps etc.

Using the smart terminal blocks of the indoor units together with the existing infrastructure drastically reduces the number of cables needed to collect these field signals and the labour required to route the cables to the centralised units. A number of different input and output functions of varying complexity are possible, depending on whether the terminal block is associated with an indoor or an outdoor unit.

Using the smart terminal blocks of the indoor units together with the existing infrastructure drastically reduces the number of cables needed to collect these field signals and the labour required to route the cables to the centralised units. A number of different input and output functions of varying complexity are possible, depending on whether the terminal block is associated with an indoor or an outdoor unit.

Adapters for external signals

Mitsubishi Electric also offers a number of different external signal connection adapter kits for both outdoor and indoor units, to cater for the specific needs of the installation.

The details of the adapter kits specified below are described in the following pages:

- PAC-SC36NA: External signal adapter for outdoor units
- PAC-SC37SA-E: External signal adapter for outdoor units
- PAC-SE55RA: External signal adapter for indoor units
- PAC-SA88HA: External signal adapter for indoor units

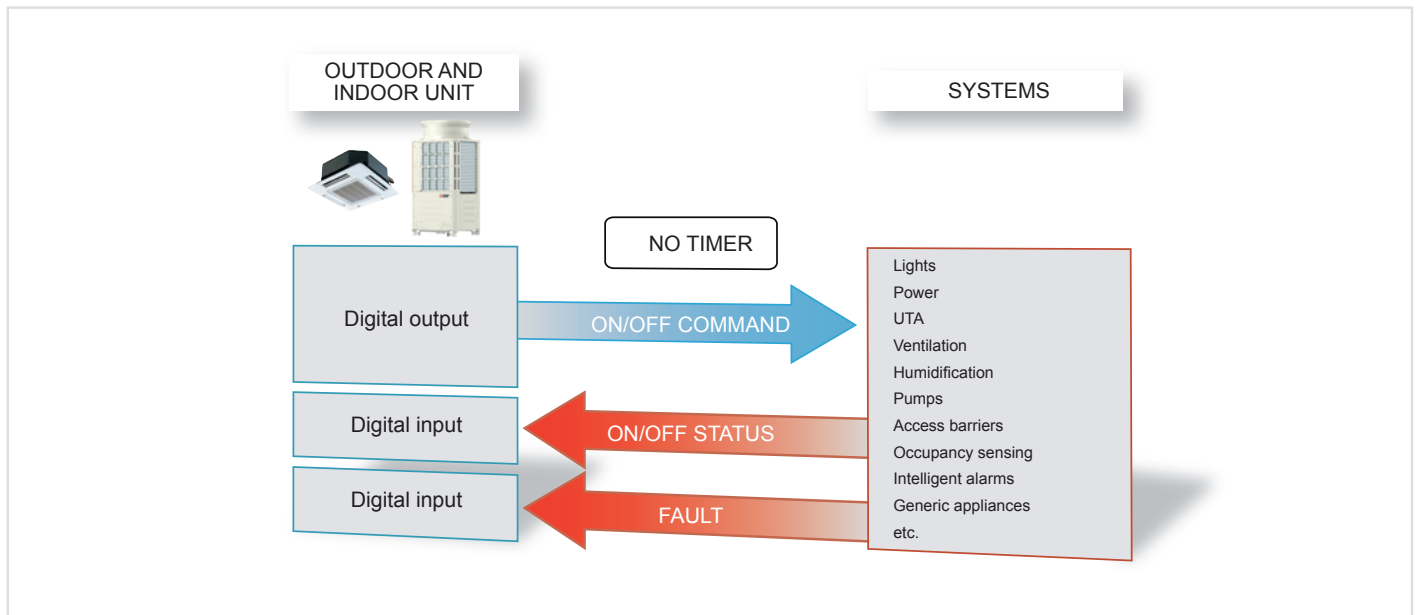

PAC-SC36NA

EXTERNAL SIGNAL ADAPTER FOR OUTDOOR UNITS

PAC-SC36NA on connector CN3D

The PAC-SC36NA external signal adapter kit is interfaced with the outdoor unit via a connector on the control board of the unit itself. In this case, the three wire contact is used to enable/disable quiet mode and to control the capacity of the outdoor unit (requires pre-configuration of specific dip switches on outdoor unit).

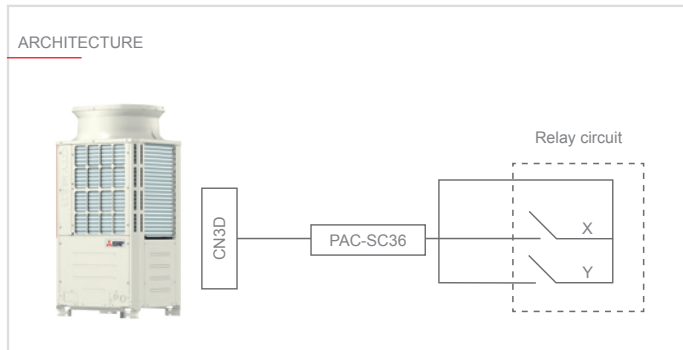

QUIET MODE	
CONTACT X (Y always closed)	
Open	Closed
Not active	Active

4 STEP CAPACITY CONTROL		CONTACT X	
		OPEN	CLOSED
Contact Y	Open	100%	75%
	Closed	0%	50%

2 STEP CAPACITY CONTROL	
CONTACT Y (X always closed)	
Open	Closed
100%	0%

PAC-SC36NA on connector CN3N

In this case, the PAC-SC36NA adapter is used to implement the Auto-Changeover function, which forces the outdoor unit to switch between heating/cooling modes (for heat pump systems only).

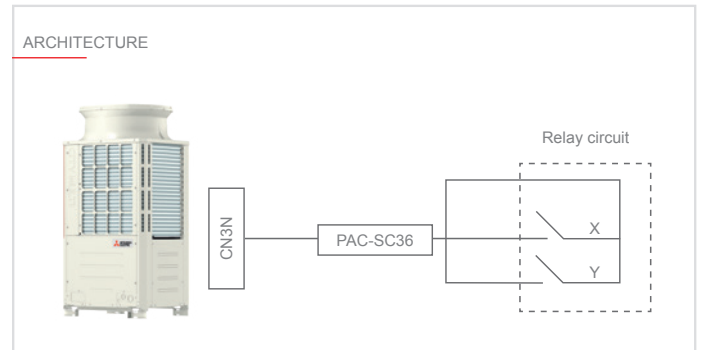

The control functions are implemented as follows:

UNIT STATUS		CONTACT X	
		OPEN	CLOSED
Contact Y	Open	Normal	Normal
	Closed	Cooling	Heating

PAC-SC37SA-E

EXTERNAL SIGNAL ADAPTER FOR OUTDOOR UNITS

PAC-SE55RA

EXTERNAL SIGNAL ADAPTER FOR INDOOR UNITS

PAC-SC37SA-E on connector CN51

The PACSC37SA-E external signal adapter kit is used to produce an **output** signal identifying the operating mode of the outdoor unit. This may, for example, be used to activate an alarm system when the unit signals that it is in error mode. The contact is connected to the outdoor unit via connector CN51 on the controller board.

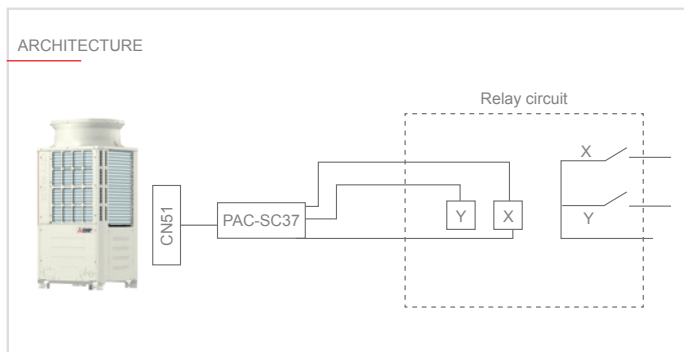

The control functions are implemented as follows:

STATUS OUTPUT		CONTACT X	
		OPEN	CLOSED
Contact Y	Open	Thermo OFF	Error
	Closed	Thermo ON	Error

PAC-SE55RA ON CONNECTOR CN32

The PAC-SE55RA external signal adapter kit is used force an indoor unit into run or stop state, with the possibility of disabling the relative remote controller. The contact is connected to the indoor unit via connector CN32 on the controller board.

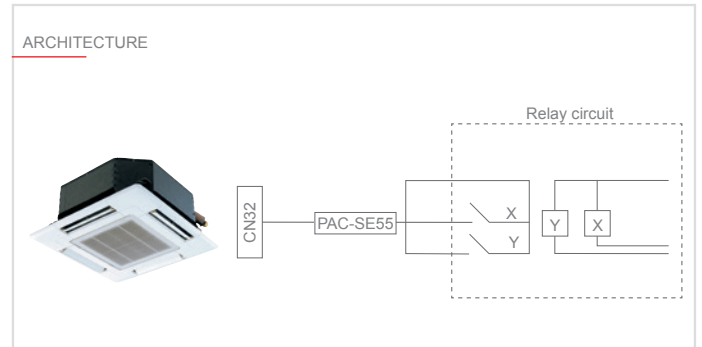

The control functions are implemented as follows:

1. Contact Y

- a. Contact OPEN:
Remote control: indoor unit controlled from remote controller
- b. Contact CLOSED:
Switch control: indoor unit controlled from contact X

2. Contact X

- a. Contact OPEN:
Stop: indoor unit in STOP state and cannot be activated from remote control
- b. Contact CLOSED:
Run: indoor unit in RUN state and cannot be deactivated from remote control



PAC-SA88HA

EXTERNAL SIGNAL ADAPTER FOR INDOOR UNITS

PAC-SA88HA on connector CN51

The terminal board is used to deliver a run/stop input signal to the indoor unit and produce an output signal identifying the operating status of the unit.

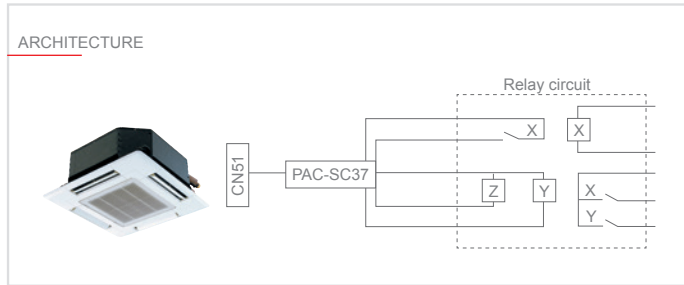

The control functions are implemented as follows:

Input

1. Contact Y

- a. Impulse ON/OFF (200ms or longer): switch to RUN if in STOP state, switch to STOP if in RUN state

Output

2. Contact Y

- a. Contact OPEN: Stop: indoor unit in STOP state
- b. Contact CLOSED: Run: indoor unit in RUN state

3. Contact Z

- a. Contact OPEN: Normal: indoor unit NOT in error state
- b. Contact CLOSED: Error: indoor unit in ERROR state

PAC-SA88HA on connector CN52

The terminal board is used to deliver a Thermo-OFF input signal to the indoor unit, or to produce a number of different output signals identifying the operating mode of the unit.

The control functions are implemented as follows:

Output

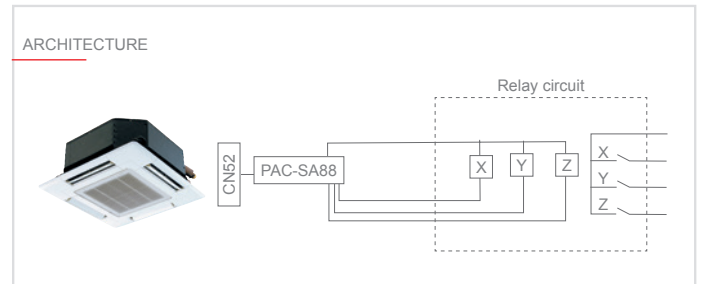

1. Contact X

- a. Contact CLOSED and SW1-5 in OFF state: RUN output for indoor unit ventilation mode
- b. Contact CLOSED and SW1-5 in ON state: Thermo-ON output when indoor unit is in thermal power demand state

2. Contact Y

- a. Contact CLOSED: Cool/Dry output when indoor unit is in cooling or dehumidifying mode

3. Contact Z

- a. Contact CLOSED: Heating output when indoor unit is in heating mode

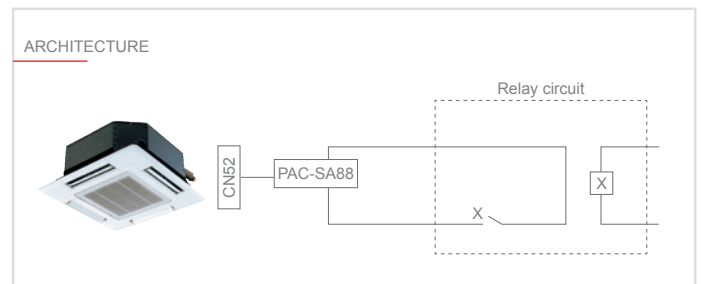

1. Contact X

- a. Contact CLOSED: indoor unit is forced to Thermo-OFF mode
- b. Contact OPEN: indoor unit is free to operate as required



BMS integration



XML

ETHERNET BASED BMS INTEGRATION



AE-200



EW-50

XML - Ethernet based BMS integration

XML is an innovative new communication system developed specifically for exchanging data over the web. XML makes it possible to create custom software extremely simply, which can even be used with a standard internet browser. The XML protocol makes it possible to integrate with a BMS system using the AE-200E/EW-50 WEB Server centralised controllers, with no additional dedicated hardware interfaces. As all the information necessary for the BMS system is available in XML format directly over the Ethernet communication port of the AE-200E / EW-50

controller, it is simply necessary to connect both the AE-200E / EW-50 WEB Server centralised controllers and the BMS computer system to the same network. Connecting to a BMS system with the XML protocol is extremely simple, as the Ethernet network platform is used. No dedicated conversion or interface hardware is needed, as shown in the typical layout schematic.

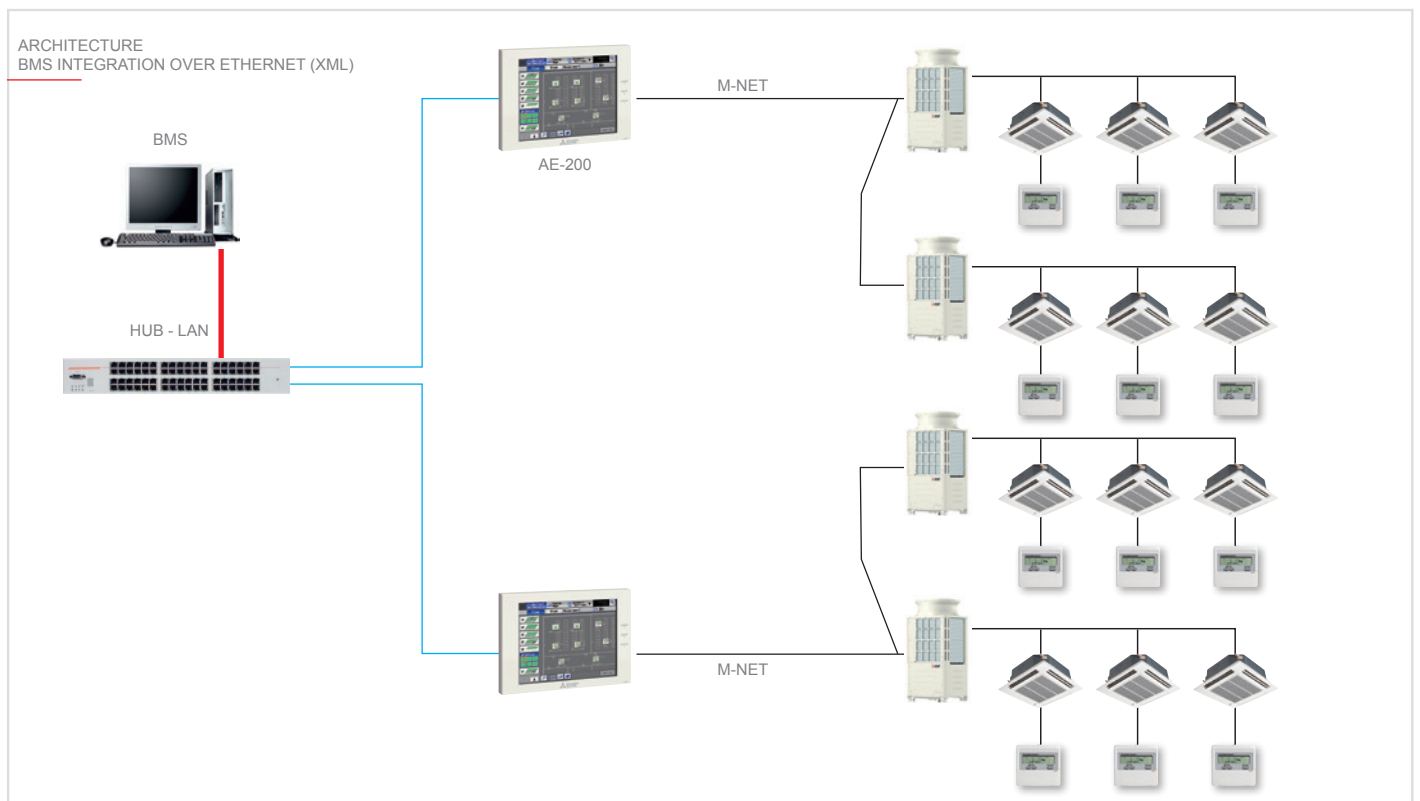

LMAP04

BMS FOR LONWORKS® NETWORKS



LMAP - BMS integration for LonWorks® networks

The LMAP04 interface allows Mitsubishi Electric air conditioners to communicate with third party BMS supervisor and management systems through the LonWorks® network system. The hardware of the interface consists of an electronic board with software integrated in the board itself, which needs no configuration.

The LMAP04 interface may be installed with any remote control or centralised controller of the Mitsubishi Electric range. Each LMAP04 interface can control up to 50 indoor units, each with its own unique address. In installations with AE-200E / EW-50 WEB Server centralised controllers, the LMAP04 interface offers the same modularity as the controllers themselves. In these cases, a separate interface must be installed for each centralised controller.

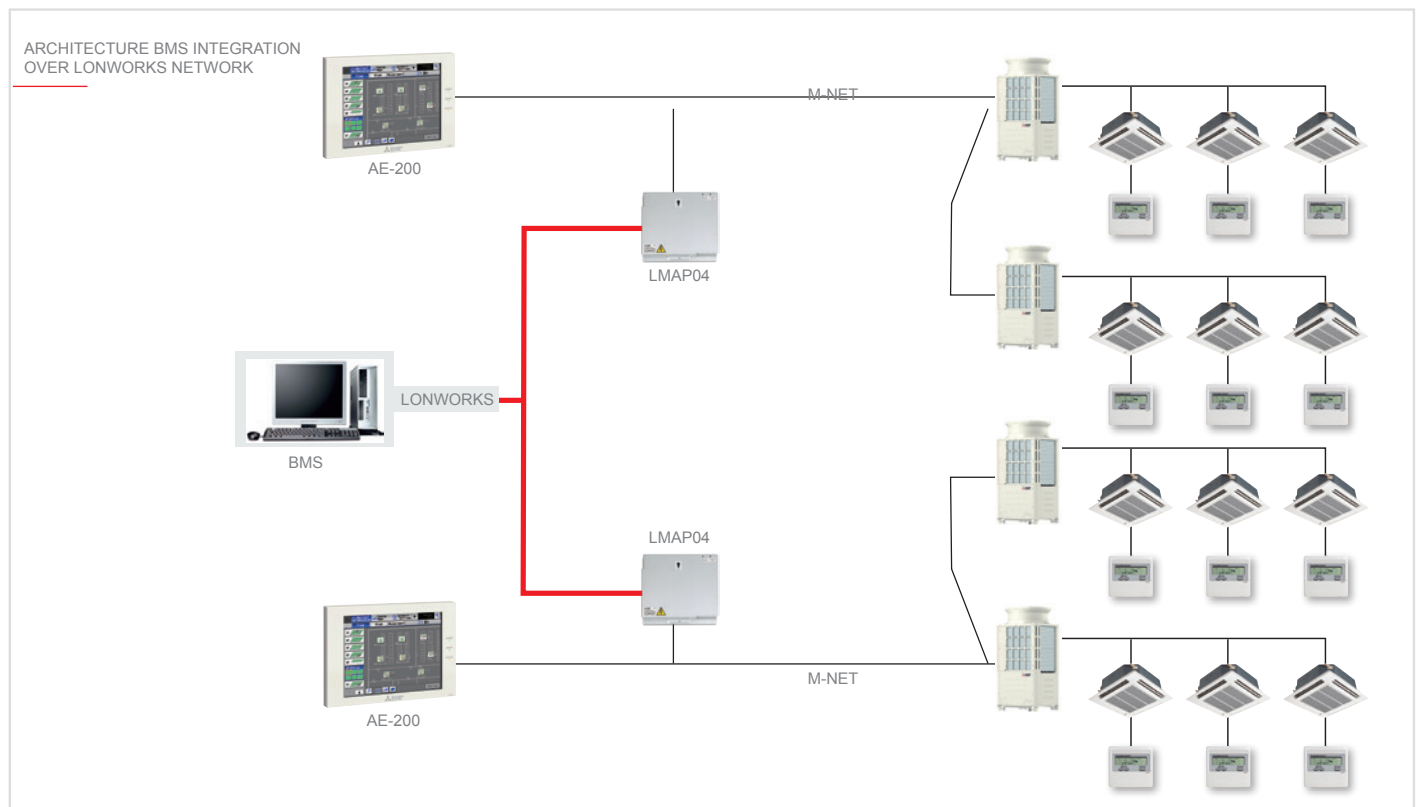

FUNCTIONS	
OPERATION	
FUNCTION	DESCRIPTION
On/Off	Switch unit on/off
Mode	Set operating mode
Fan speed	Set fan speed
Set temperature	Set temperature setpoint
Set Temperature (Cool)	Set temperature in cooling mode for Dual Setpoint function
Set Temperature (Heat)	Set temperature in heating mode for Dual Setpoint function
Set Temperature (Auto)	Set temperature in Auto mode for Dual Setpoint function
Set Setback Temp (High)	Set upper limit for maintenance temperature function
Set settable temp. range	Set settable temp. range
Set Setback Temp (Low)	Set lower limit for maintenance temperature function
Reset filter indicator	Reset filter indicator
Disable local On/Off	Disable local On/Off control
Disable local mode selection	Disable local mode selection
Disable local filter indicator reset	Disable/enable local operating mode selection
Disable temperature setting	Disable/enable setpoint setting
Set Lossnay mode	Set Lossnay operating mode
Force off	Force unit to off state
MONITORING	
FUNCTION	DESCRIPTION
On/Off	View unit on/off state
Mode	View unit operating mode
Fan speed	View fan speed
Set temperature	View temperature setpoint
Set Temperature (Cool)	View setpoint temperature for cooling mode with Dual Setpoint function
Set Temperature (Heat)	View setpoint temperature for heating mode with Dual Setpoint function
Set Temperature (Auto)	View setpoint temperature for Auto mode with Dual Setpoint function
Lossnay mode	View Lossnay unit operating mode
Filter indicator	View filter indicator signal
Indoor temperature	View indoor ambient temperature
Disable local On/Off	View status of Disable local On/Off function
Disable local mode selection	View status of Disable local mode selection function
Disable local filter indicator reset	View status of Disable local filter indicator reset function
Disable temperature setting	View status of Disable temperature setpoint setting function
Force off	View Force off function status
Alarm signal	View alarm signal
Error code	View error code
Communication status	View communication status

BACnet® Pin code

BMS INTEGRATION FOR BACNET® NETWORKS

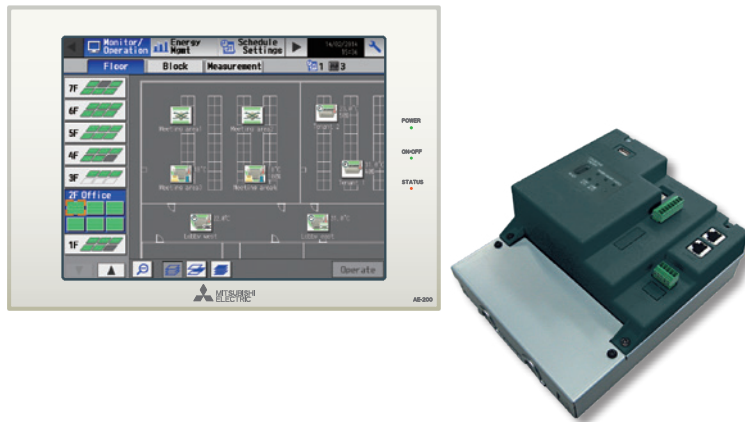

PIN code for interfacing with BACnet® network

The BACnet® protocol was originally developed by ASHRAE in North America specifically for HVAC applications (Heat, Ventilation, Air Conditioning).

It was subsequently also adopted in Europe as one of the standard communication solutions for air conditioning systems, together with LonWorks®, and other protocols. The capabilities of the BACnet® protocol make it the ideal system for large installations and for complex, multi-level building management processes.

A new function developed for WEB Server 3D centralised controllers

(AE-200 and EW-50) now makes it possible to interface Mitsubishi Electric systems directly with the BACnet® network of the building without installing additional hardware components.

The centralised controller is connected to the network via a dedicated Ethernet port on the back of the controller itself, included in addition to the port already used for connection to a LAN local network

A BACnet® PIN code license must be purchased for each individual centralised controller. Each centralised controller enabled with a BACnet® PIN code license may manage up to 50 indoor units and 50 groups.

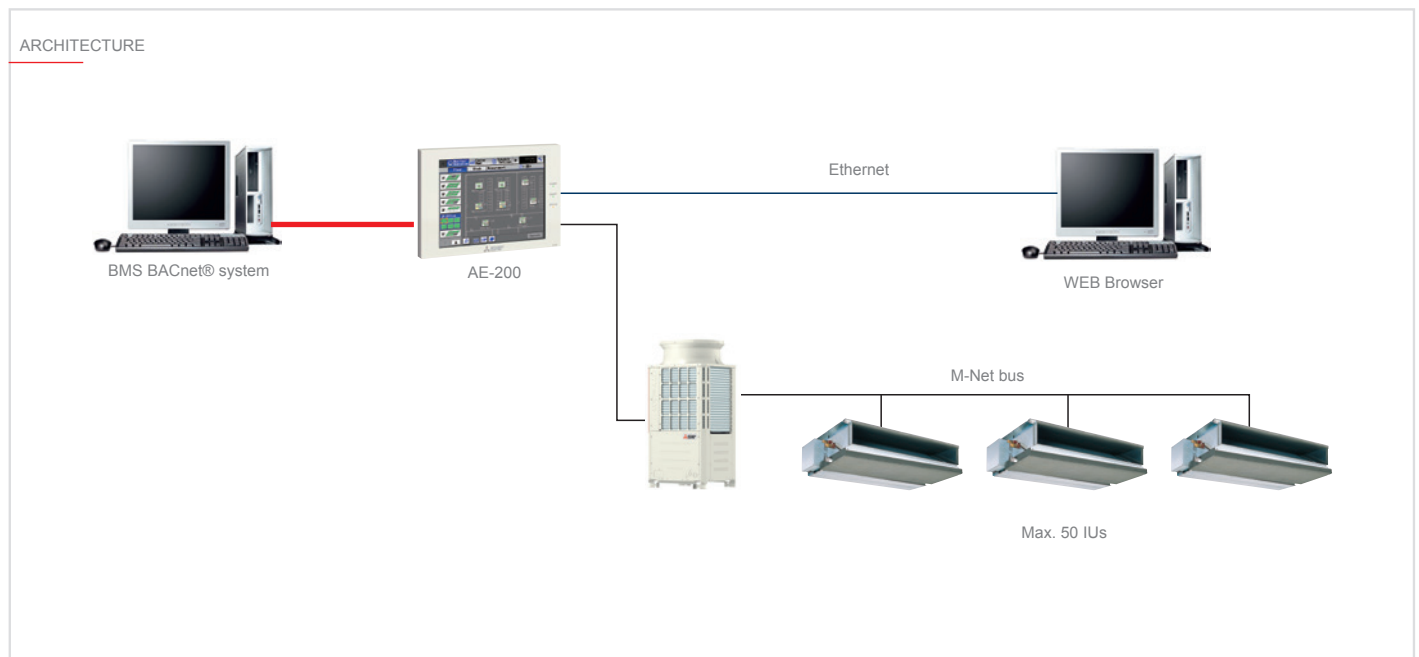

Functions

OPERATION	
FUNCTION	DESCRIPTION
On/Off	Switch unit on/off
Mode	Set operating mode
Fan speed	Set fan speed
Set temperature	Set temperature setpoint
Set Temperature (Cool)	Set temperature in cooling mode for Dual Setpoint function
Set Temperature (Heat)	Set temperature in heating mode for Dual Setpoint function
Set Temperature (Auto)	Set temperature in Auto mode for Dual Setpoint function
Set Setback Temp (High)	Set upper limit for maintenance temperature function
Set Setback Temp (Low)	Set lower limit for maintenance temperature function
Reset filter indicator	Reset filter indicator
Disable local On/Off	Disable local On/Off control
Disable local mode selection	Disable/enable local operating mode selection
Disable local filter indicator reset	View status of Disable filter indicator reset function
Disable temperature setting	Disable/enable setpoint setting
MONITORING	
FUNCTION	DESCRIPTION
Force off	Force unit to off state
On/Off	View unit on/off state
Mode	View unit operating mode
Fan speed	View fan speed
Set temperature	View temperature setpoint
Set Temperature (Cool)	View setpoint temperature for cooling mode with Dual Setpoint function
Set Temperature (Heat)	View setpoint temperature for heating mode with Dual Setpoint function
Set Temperature (Auto)	View setpoint temperature for Auto mode with Dual Setpoint function
Set Setback Temp (High)	View upper limit set for maintenance temperature function
Set Setback Temp (Low)	View lower limit set for maintenance temperature function
Filter indicator	View filter indicator signal
Indoor temperature	View indoor ambient temperature
Disable local On/Off	View status of Disable local On/Off function
Disable local mode selection	View status of Disable local mode selection function
Disable local filter indicator reset	View status of Disable filter indicator reset function
Disable temperature setting	View status of Disable temperature setpoint setting function
Force off	View Force off function status
Alarm signal	View alarm signal
Error code	View error code
Communication status	View communication status

ME-AC-MBS-100

BMS INTERFACE FOR MODBUS® NETWORKS



ME-AC-MBS-100 – BMS interface for Modbus® networks

The Modbus® communication protocol was initially used for PLC networks. Mitsubishi Electric offers an interface capable of controlling up to 100 indoor units (ME-AC-MBS-100) for managing a VRF-HVRF CITY MULTI installation with a BMS system.

The interface is connected to the Modbus® supervisor system either by an RS232/RS485 serial connection or a TCP/IP over Ethernet connection, and is connected to the Mitsubishi Electric VRF-HVRF CITY MULTI installation with a BMS system.

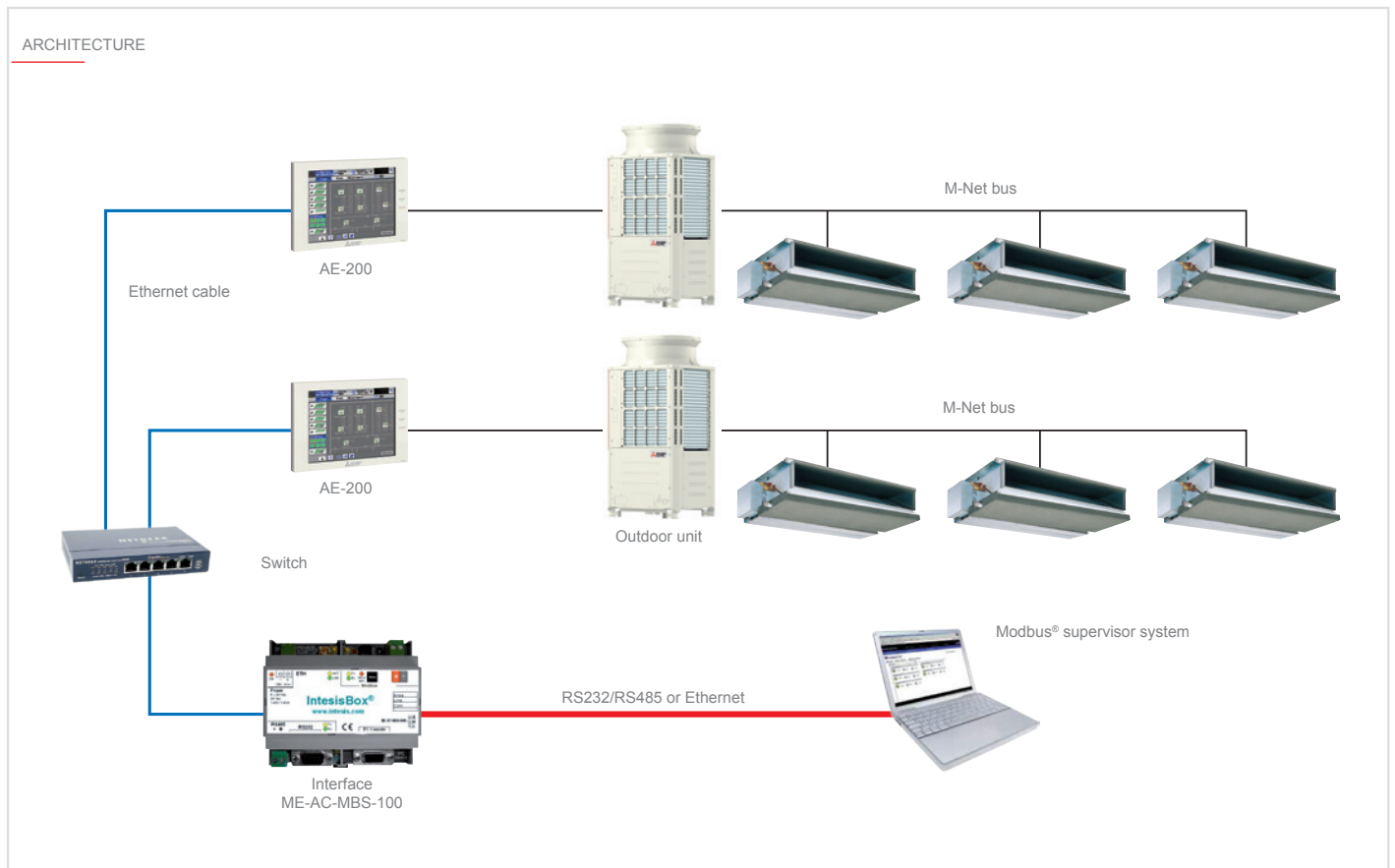

Functions

OPERATION	
FUNCTION	DESCRIPTION
On/Off	Switch unit on/off
Mode	Set operating mode
Set temperature	Set temperature setpoint
Air flow direction	Set air flow direction
Fan speed	Set fan speed
Disable remote control	Disable/enable control from remote controller
Disable local On/Off	Disable local On/Off control
Disable local mode selection	Disable/enable local operating mode selection
Disable temperature setting	Disable/enable setpoint setting
Disable local filter indicator reset	Disable/enable filter indicator reset
Set Lossnay ventilation	Set Lossnay ventilation speed
Reset filter indicator	Reset filter indicator
Reset error status	Reset error status
Active polling	Enable/disable group polling
Force off	Force unit to off state
MONITORING	
FUNCTION	DESCRIPTION
On/Off	Switch unit on/off
Communication error	Communication error with centralised controller
Mode	Set operating mode
Set temperature	Set temperature setpoint
Air flow direction	Set air flow direction
Fan speed	Set fan speed
Disable remote control	Disable/enable control from remote controller
Disable local On/Off	Disable local On/Off control
Disable local mode selection	Disable/enable local operating mode selection
Disable temperature setting	Disable/enable setpoint setting
Disable local filter indicator reset	Disable/enable filter indicator reset
Set Lossnay ventilation	Set Lossnay ventilation speed
Filter signal	'Filter dirty' indicator signal
Error signal	Signal indicating unit in error state
Indoor temperature	View indoor ambient temperature
Reset filter indicator	Reset filter indicator
Reset error status	Reset error status
Group communication error	Group communication error
Active polling	View group polling disabled/enabled status
Force off	Force unit to off state

ME-AC-KNX-100

BMS INTERFACE FOR KNX® NETWORKS



ME-AC-KNX-100 – BMS interface for KNX® networks

KNX® is one of the global standards for automated household and building control. This open protocol ensures cross-compatibility between products from different manufacturers.

Mitsubishi Electric offers an interface capable of controlling up to 100 indoor units (ME AC KNX – 100) for managing a VRF-HVRF CITY MULTI installation with a BMS system. The interface is connected directly to the EIB bus linked to the KNX® network, and to the Mitsubishi Electric VRF-HVRF CITY MULTI installation by Ethernet.

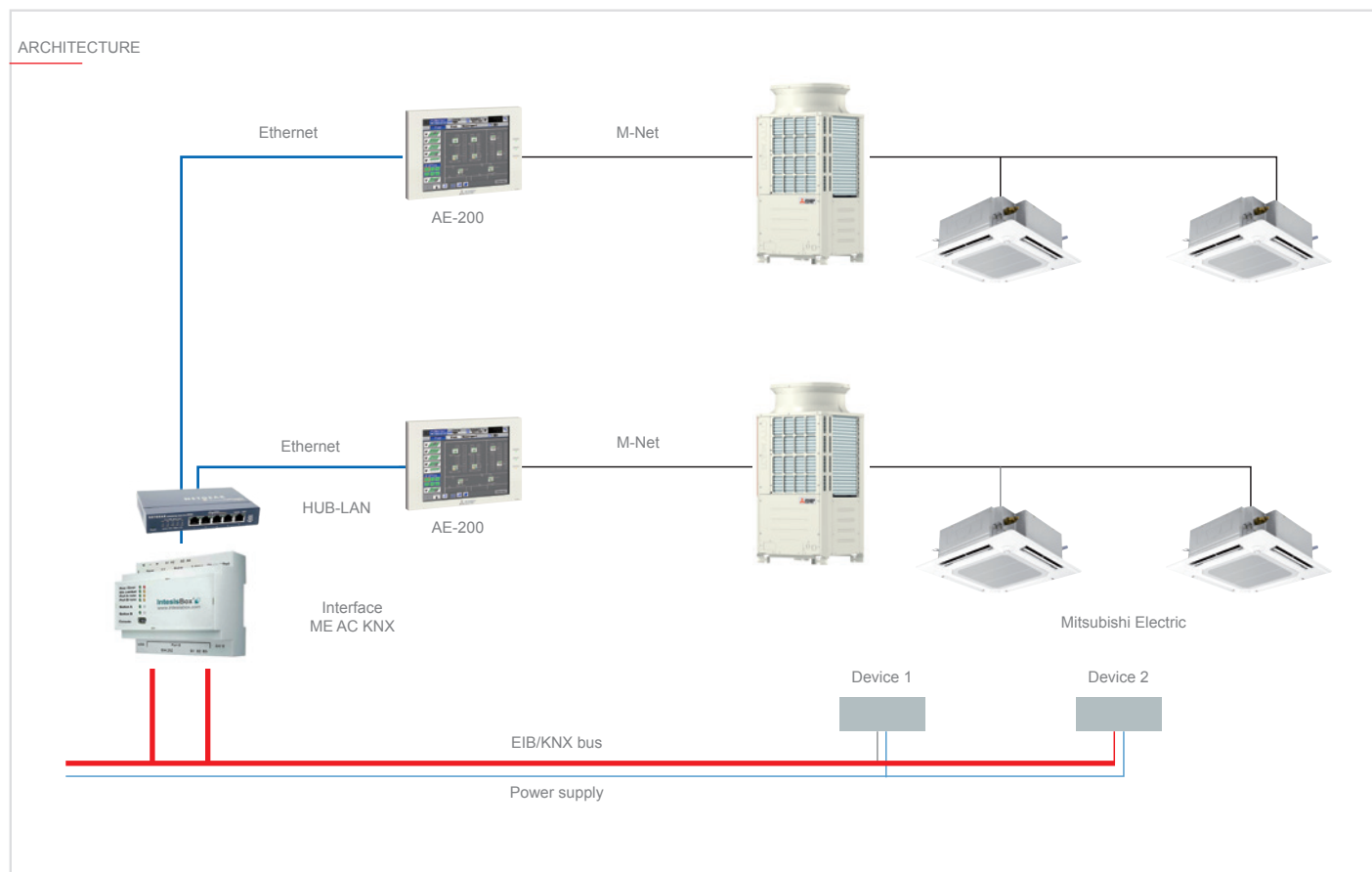

Functions

OPERATION	
FUNCTION	DESCRIPTION
On/Off	Switch unit on/off
Mode	Set operating mode
Set temperature	Set temperature setpoint
Air flow direction	Set air flow direction
Fan speed	Set fan speed
Disable remote control	Disable/enable control from remote controller
Disable local On/Off	Disable local On/Off control
Disable local mode selection	Disable/enable local operating mode selection
Disable temperature setting	Disable/enable setpoint setting
Disable local filter indicator reset	Disable/enable filter indicator reset
Set Lossnay ventilation	Set Lossnay ventilation speed
Reset filter indicator	Reset filter indicator
Reset error status	Reset error status
Inlet Temp	Set virtual setpoint (temperature reading from KNK)
MONITORING	
FUNCTION	DESCRIPTION
On/Off	Switch unit on/off
Communication error	Communication error with centralised controller
Mode	Set operating mode
Set temperature	Set temperature setpoint
Air flow direction	Set air flow direction
Fan speed	Set fan speed
Disable remote control	Disable/enable control from remote controller
Disable local On/Off	Disable local On/Off control
Disable local mode selection	Disable/enable local operating mode selection
Disable temperature setting	Disable/enable setpoint setting
Disable local filter indicator reset	View status of Disable filter indicator reset function
Set Lossnay ventilation	Set Lossnay ventilation speed
Filter signal	'Filter dirty' indicator signal
Error signal	Signal indicating unit in error state
Indoor temperature	View indoor ambient temperature
Reset filter indicator	Reset filter indicator
Reset error status	Reset error status
Group communication error	Group communication error
Inlet Temp	View virtual temperature value (from KNK)

Centralised control setting and synchronisation system: CLIMASYNC



CLIMASYNC

CLIMASYNC is a software application developed specifically by Mitsubishi Electric to optimise the synchronised, operation, management and setting of Mitsubishi VRF systems to improve comfort and energy efficiency.

CLIMASYNC offers a suite of functions, customisable by the administrator of the installation, for optimising the operation of the indoor units (or groups of indoor units) in the system in relation to a number of parameters such as outdoor temperature.

It also makes it possible to supervise and control indoor units from a Web Server centralised controller over an Ethernet network.

The software introduces additional control logic and functions not native to VRF systems.

What sets this solution apart is that it allows the transverse synchronisation of multiple VRF systems with multiple centralised controllers (Web Server).

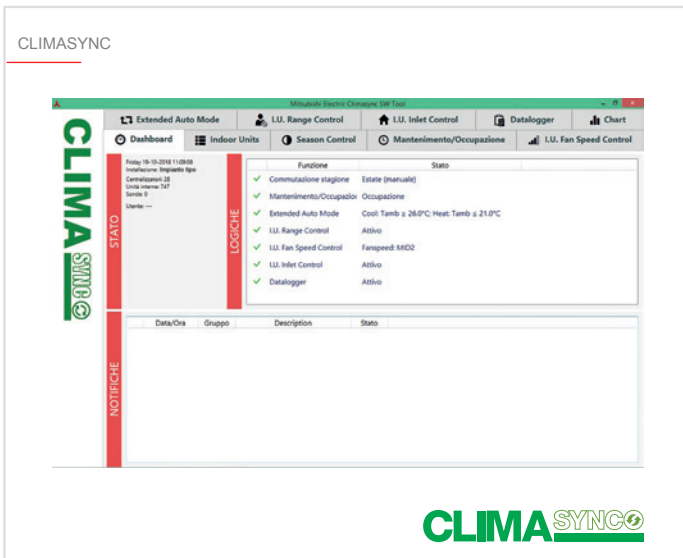

Fan speed control

The "Fan management" function may be used to set and synchronise a specific fan speed for all indoor units enabled for the function in accordance with a repeating weekly timer schedule.

The administrator simply has to select the indoor units enabled for the function, select the days of the week, and then select the fan speed settings for each time bracket. While the function is active, even though the user can continue to modify fan speed from their remote control, CLIMASYNC will force fan speed to the setting configured by the administrator. During time brackets for which the function is not enabled, the user may set the fan speed locally with complete freedom.

Switching between Maintenance/Occupancy modes during weekly time schedule

The switching function lets the administrator programme the indoor units to switch automatically between "Maintenance" and "Occupancy" modes in accordance with a weekly timer schedule with a resolution of one hour. "Maintenance" mode requires a minimum or maximum setpoint to be defined (depending on season) to prevent the VRF-HVRF CITY MULTI system from switching off completely during unoccupied periods. This is particularly useful for winter operation, where restarting the system from very low indoor temperature conditions will significantly increase energy consumption and increase the time required for capacity control and modulation.

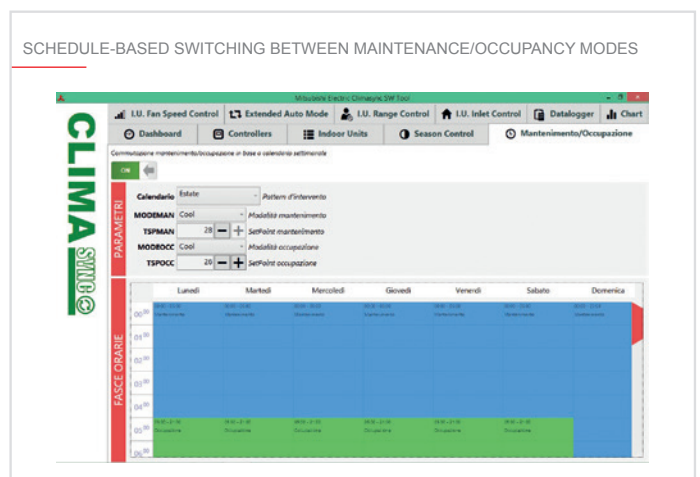

Extended range switching between AutoCool/AutoHeat modes

The EAM (Extended Auto Mode) function allows automatic switching mode to operate over a more extended range not constrained directly by setpoints, to allow the system to function predominantly in either Cooling or Heating mode.

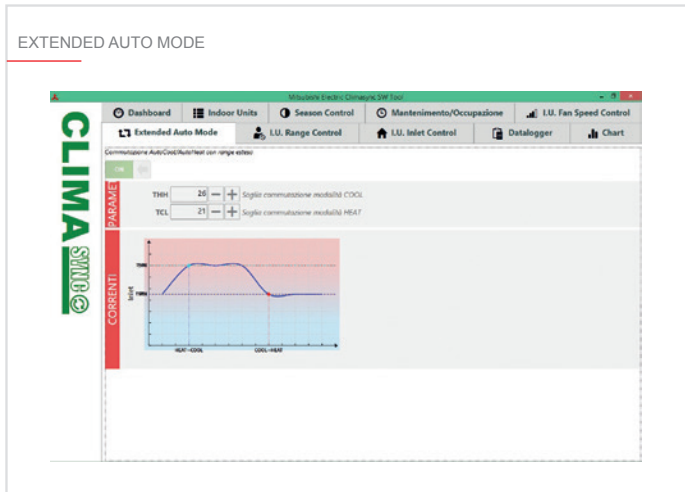

Inlet temperature control

The IC (Inlet Control) function monitors the inlet temperature values of the indoor units, compares these values against 2 configurable limits (one for Cooling mode and one for Heating mode), and indicates any indoor units with an inlet temperature not within the permitted limit.

Note: if the “e-mail notification” function is enabled, daily report e-mails are sent specifying any units not within the permitted temperature range.

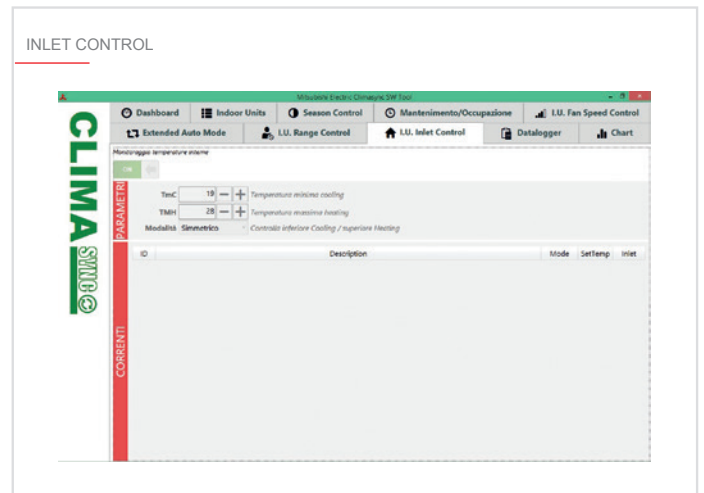

Settable setpoint range control

The RC (Range Control) function may be used to limit the setpoint temperature range settable by the user from the remote control either for individual units or collectively for all the indoor units in the installation. CLIMASYNC queries the settings for each indoor unit once every minute and corrects any settings made by users not within the permitted range. The permitted deviation from the setpoint is editable and configurable by the administrator.

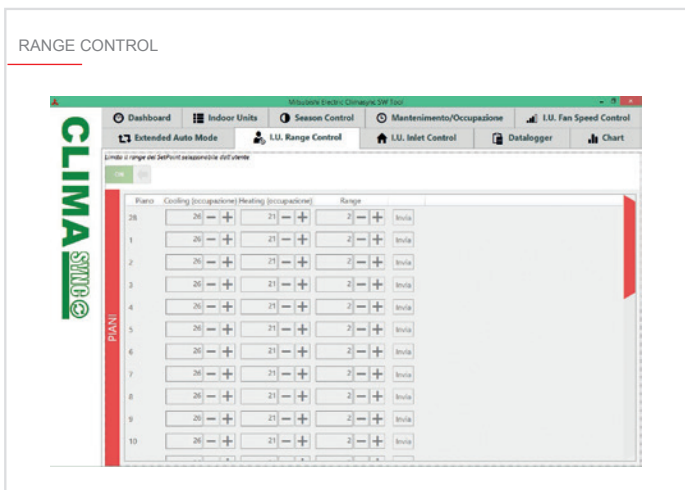

Season Control

The SC (Season Control) functions switches all the indoor units in the installation between Summer/Winter mode either automatically, in accordance with an annual schedule, or in centralised manual mode.

- 'Winter' and 'summer' seasonal operation refer respectively to heating and cooling mode.
- When automatic season control is enabled, the system is switched automatically between modes in accordance with two numerical parameters defining the start day for summer mode and the start day for winter mode.
- When automatic season control is disabled, the system may be switched manually between modes (Manual summer/Manual winter).

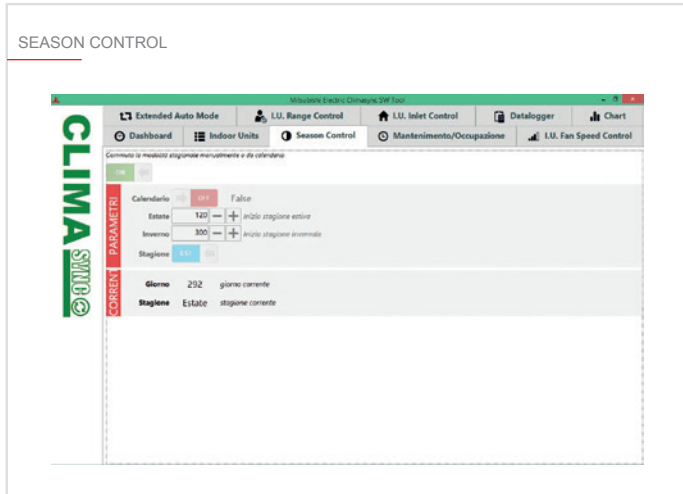

Installation

- This function requires a centralised controller (AE-200 or EW50) and a PC (not included), which must be connected to each other via an Ethernet LAN network.
- CLIMASYNC software may only be installed once the installation is installed completely and in operation
- Different versions of CLIMASYNC may be purchased depending on the maximum number of indoor units in the installation (50, 100, 150 or 200). Purchase of the CLIMASYNC software includes:
 - On-site installation of software
 - On-site training of personnel assigned to using software
 - Operator manual

Advantages for the user

- Control and synchronise the air conditioning functions of multiple systems in the same building and managed by different centralised controllers
- Customisable ambient comfort in each indoor space
- Eliminates all energy wastage/temperature overshoots
- Saves energy
- Maintains log of external temperature and setpoint values which can be exported by the software administrator for analysing system behaviour and performance history.









LIVING ENVIRONMENTAL SYSTEMS

Centro Direzionale Colleoni
Viale Colleoni, 7 - Palazzo Sirio
20864 Agrate Brianza (MB)
tel. 039.60531 - fax 039.6053223
e-mail: clima@it.mee.com



The equipment described in this catalogue contain fluorinated gasses such as HFC-32 (GWP 675), HFC-410A (GWP 2088). Installation of those equipment must be executed by professional installer based on EU reg. 303/2008 and 517/2014

CONTROL SYSTEM CATALOGUE
E-2204235(17370)

Specifications are subject to change without notice



E-2204235



ies.mitsubishielectric.it/en/products/