

PARTS

Diaphragm Flushometer Exposed Base Model Flush Valve 624BXXX

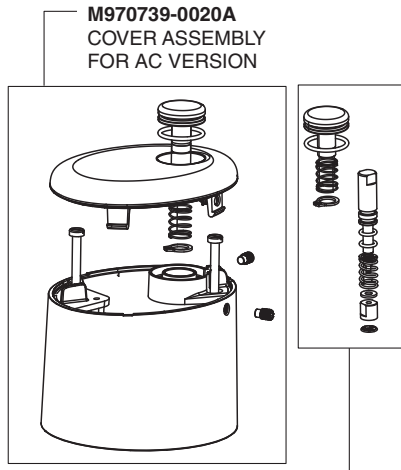

M970739-0020A
COVER ASSEMBLY
FOR AC VERSION

M970728-0020A
OVERRIDE BUTTON ASSEMBLY

M970734-0070130A
SENSOR ASSEMBLY
FOR URINAL FV 0.125GPF

M970734-0070500A
SENSOR ASSEMBLY
FOR URINAL FV 0.5 GPF

M970734-0071000A
SENSOR ASSEMBLY
FOR URINAL FV 1.0 GPF

M970734-0071100A
SENSOR ASSEMBLY
FOR TOILET FV 1.1 GPF

M970734-0071280A
SENSOR ASSEMBLY
FOR TOILET FV 1.28 GPF

M970734-0071600A
SENSOR ASSEMBLY
FOR TOILET FV 1.6 GPF

M970734-0075000A
SENSOR ASSEMBLY
FOR TOILET 1.28/1.1 GPF

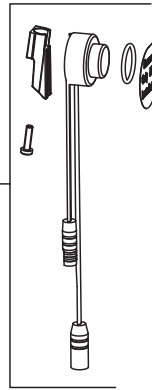

M970735-0070A
LOWER HALF
KIT

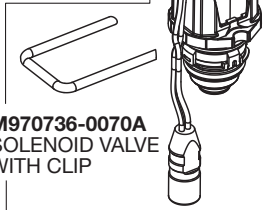

M970736-0070A
SOLENOID VALVE
WITH CLIP

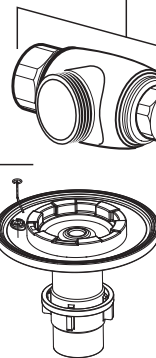
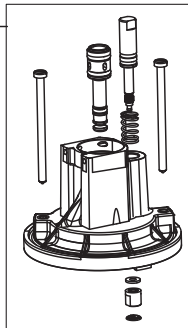

M970737-0070A
DIAPHRAGM ASSEMBLY
0.125GPF

M970738-0070A
DIAPHRAGM ASSEMBLY
REMAINING FLOW RATES

A955056-0020A
1" STOP VALVE KIT

M955058-0020A
3/4" STOP VALVE KIT

A955057-0020A
1" INLET PIPE
ASSEMBLY

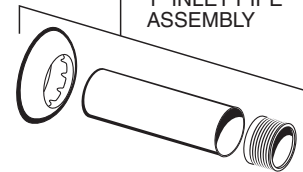

M952261-0020A
3/4" INLET PIPE
ASSEMBLY

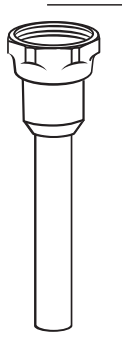
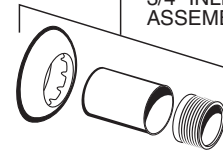

M964412-0020A
3/4" VACUUM
BREAKER

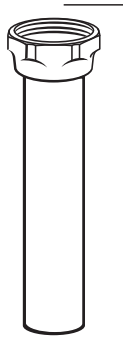

M964411-0020A
1-1/2" VACUUM
BREAKER

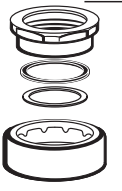

M952262-0020A
3/4" ESCUTCHEON
KIT

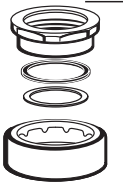

M952269-0020A
1-1/2" ESCUTCHEON
KIT



HOT LINE FOR HELP

For toll-free information and answers to your questions, call:
(844) CRT-TEAM / (844) 278-8326
Mon. - Fri. 8:00 a.m. to 8:00 p.m. EST Saturday 10:00 a.m. to 4:00 p.m. EST
IN MEXICO 01-800-839-1200
IN CANADA 1-800-387-0369 (TORONTO 1-905-306-1093)
Weekdays 8:00 a.m. to 7:00 p.m. EST

Product names listed herein are trademarks of AS America, Inc. ©2022

To learn more about American Standard Selectronic® Products visit our website at:
www.americanstandard-us.com or e-mail us at: CRTTEAM@ixilamericas.com

PIÈCES

Robinet de chasse à diaphragme exposé, modèle de base-624BXXX

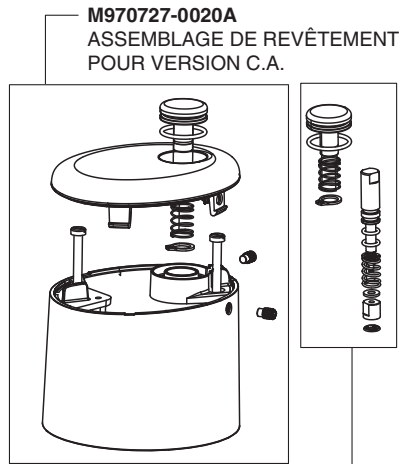

M970727-0020A
ASSEMBLAGE DE REVÊTEMENT
POUR VERSION C.A.

M970728-0020A
ASSEMBLAGE DU BOUTON
DE COMMANDE

M970734-0070130A
ASSEMBLAGE DU CAPTEUR
POUR URINOIR FV, 0,125 GPC

M970734-0070500A
ASSEMBLAGE DU CAPTEUR
POUR URINOIR FV, 0,5 GPC

M970734-0071000A
ASSEMBLAGE DU CAPTEUR
POUR URINOIR FV, 1,0 GPC

M970734-0071100A
ASSEMBLAGE DU CAPTEUR
POUR TOILETTE FV, 1,1 GPC

M970734-0071280A
ASSEMBLAGE DU CAPTEUR
POUR TOILETTE FV, 1,28 GPC

M970734-0071600A
ASSEMBLAGE DU CAPTEUR
POUR TOILETTE FV, 1,6 GPC

M970734-0075000A
ASSEMBLAGE DU CAPTEUR
POUR TOILETTE 1.28/1.1 GPC

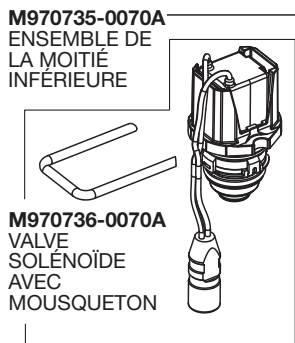
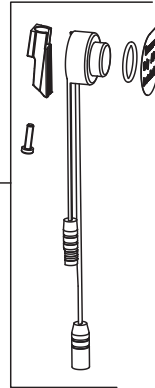

M970735-0070A
ENSEMBLE DE
LA MOITIÉ
INFÉRIEURE

M970736-0070A
VALVE
SOLENOÏDE
AVEC
MOUSQUETON

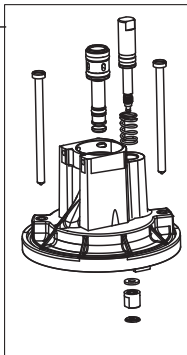

A955056-0020A

ENSEMBLE DE ROBINET D'ARRÊT, 1 PO

M955058-0020A

ENSEMBLE DE ROBINET D'ARRÊT, 3/4 PO

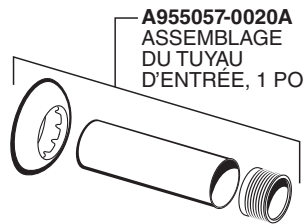
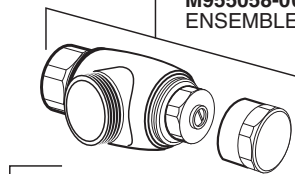

A955057-0020A
ASSEMBLAGE
DU TUYAU
D'ENTRÉE, 1 PO

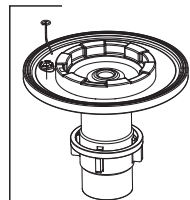

M970737-0070A
ASSEMBLAGE DU
DIAPHRAGME, 0,125 GPC

M970738-0070A
ASSEMBLAGE DU DIAPHRAGME,
DÉBITS RESTANTS

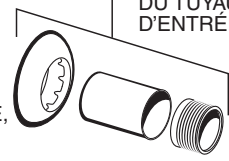

M952261-0020A
ASSEMBLAGE
DU TUYAU
D'ENTRÉE, 3/4 PO

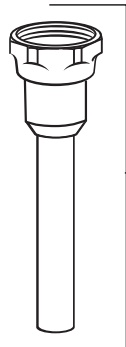

M964412-0020A
DISPOSITIF
ANTI-REFOULEMENT,
3/4 PO

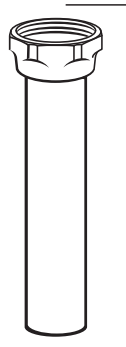

M964411-0020A
DISPOSITIF
ANTI-REFOULEMENT,
1-1/2 PO

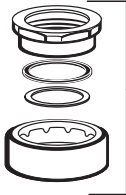

M952262-0020A
ENSEMBLE DE
PLAQUE DE
FINITION, 3/4 PO

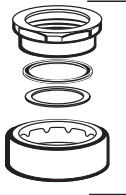

M952269-0020A
ENSEMBLE DE
PLAQUE DE
FINITION, 1-1/2 PO



SERVICE D'ASSISTANCE TÉLÉPHONIQUE
Pour toutes questions, composez sans frais le numéro suivant :
844-CRT-TEAM / 844-278-8326
Du lundi au vendredi de 8 h à 20 h, HNE Samedi de 10 h à 16 h
AU MEXIQUE 01-800-839-1200
AU CANADA 1-800-387-0369 (TORONTO 1-905-306-1093)
Du lundi au vendredi de 8 h à 19 h, HNE
Les noms des produits indiqués dans la présente sont
des marques de commerce d'AS America Inc. ©2022

Pour en savoir plus sur les produits Selectronic® d'American Standard, visitez notre site Web au www.americanstandard-us.com, ou envoyez-nous un courriel à l'adresse suivante : CRTEAM@usa.american.com

PIEZAS

Válvula de descarga con fluxómetro de diafragma expuesto modelo básico 624BXXX

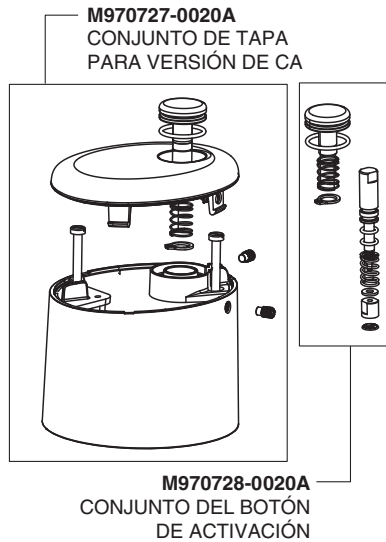

- M970734-0070130A**
CONJUNTO DEL SENSOR
PARA MINGITORIO FV 0.125 GPF
- M970734-0070500A**
CONJUNTO DEL SENSOR
PARA MINGITORIO FV 0.5 GPF
- M970734-0071000A**
CONJUNTO DEL SENSOR
PARA MINGITORIO FV 1.0 GPF
- M970734-0071100A**
CONJUNTO DEL SENSOR
PARA INODORO FV 1.1 GPF
- M970734-0071280A**
CONJUNTO DEL SENSOR
PARA INODORO FV 1.28 GPF
- M970734-0071600A**
CONJUNTO DEL SENSOR
PARA INODORO FV 1.6 GPF
- M970734-0075000A**
CONJUNTO DEL SENSOR
PARA INODORO 1.28/1.1 GPF

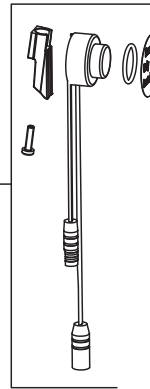

M970735-0070A
KIT DE MITAD
INFERIOR

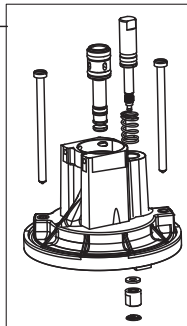

- A955056-0020A**
KIT DE VÁLVULA DE CIERRE DE 1"
- M955058-0020A**
KIT DE VÁLVULA DE CIERRE DE 3/4"

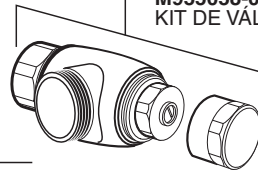

A955057-0020A
CONJUNTO DE
TUBERÍA DE
ENTRADA DE 1"

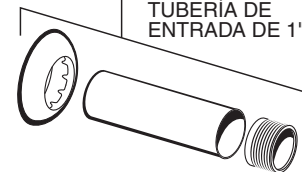

M952261-0020A
CONJUNTO DE
TUBERÍA DE
ENTRADA DE 3/4"

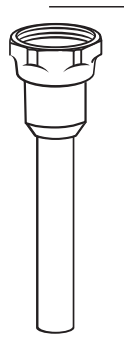
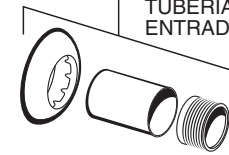

M964412-0020A
VÁLVULA DE
CONTRAFLUJO DE 3/4"

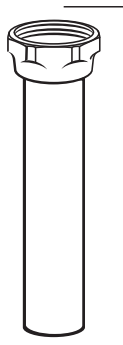

M964411-0020A
VÁLVULA DE CONTRAFLUJO
DE 1-1/2"

M970737-0070A
CONJUNTO DE
DIAFRAGMA 0.125 GPF

M970738-0070A
CAUDALES RESTANTES DEL
CONJUNTO DE DIAFRAGMA

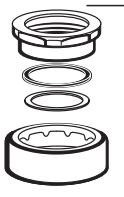
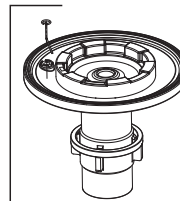

M952262-0020A
KIT DE CHAPETÓN
DE 3/4"

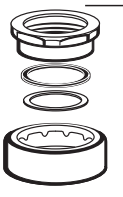

M952269-0020A
KIT DE CHAPETÓN
DE 1-1/2"



LÍNEA DE AYUDA DIRECTA
Si desea obtener información o tiene preguntas, llame sin cargo al
(844) CRT-TEAM / (844) 278-8326
de lunes a viernes de 8:00 a.m. a 8:00 p.m. Hora normal del
este y los sábados de 10:00 a.m. a 4:00 p.m.
EN MÉXICO: 01-800-839-1200
EN CANADA: 1-800-387-0369 (TORONTO: 1-905-306-1093)
Los días de semana de 8:00 a.m. a 7:00 p.m. Hora normal del este
Los nombres de producto mencionados en este documento son marcas
de comercio de AS America, Inc. ©2022

Para obtener más información sobre los productos Electronic™ de American Standard, visite nuestro
sitio web: www.americanstandard-us.com o escribanos a: CRITTEAM@lxi.american.com