

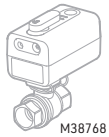

**QUICK START GUIDE**

# Braukmann L5 WiFi Water Leak Shutoff Valve



## APPLICATION

Thank you for purchasing Resideo's new L5 WiFi Water Leak Shutoff Valve. When paired with Resideo's WiFi Leak Detector(s), as soon as water is detected, the L5 could automatically shut off the water to reduce your potential water damage. This guide will take you through everything you need to know to get started.



## WHAT'S IN THE BOX?

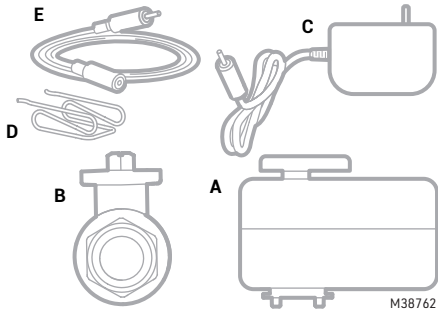

Fig. 1. Included parts.

- A. **L5 Actuator:** Connects to WiFi and controls the status of your valve.
- B. **Water Ball Valve:** Lead-free ball valve. (Can be installed in any orientation.)
- C. **Power Supply:** 10 ft power adapter used to power your L5 Actuator.
- D. **Metal Clip:** Connects the actuator with the water ball valve.
- E. **Leak Detection Cable:** This 5 ft add-on rope sensor can be connected to the L5 actuator and can be linked with multiple rope sensors to extend the detection area.

## OVERVIEW

**Auto Shutoff Through Water Leak & Freeze Sensor:** When paired with Resideo's WiFi Leak Detector(s), L5 WiFi Water Leak Shutoff Valve should be able to shut off your water line automatically before the damage becomes catastrophic. One L5 WiFi Water Leak Shutoff Valve can be paired up to 30 Resideo WiFi Leak Detectors.

**Control the L5 WiFi Water Leak Shutoff Valve Remotely Via the App:** Whether you are on your way to the airport or at a remote location, control the valve's on or off status wherever you are.

**Manual Override to Turn On or Off Water:** When needed, the valve can be turned on or off by using the emergency handle on the L5 Actuator. We recommend this handle be used only in emergencies. For normal manual override, short press the power button to open or close the valve.

**Easy Install:** Standard ball valve makes it easy for a licensed plumber to install.

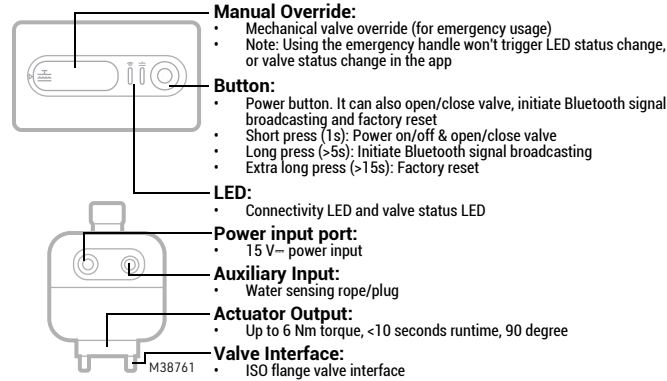

Fig. 2. Components.

## MOBILE APP SETUP

1. **Download the Resideo app.**  
Search for Resideo in the App Store or Google Play. After downloading, launch the app, register (if first time user), and then click the "+" icon at the bottom of the home screen.
2. **Follow the app guidance, choose location and name your L5 valve.**
  - a. Provide a location for your L5 valve.
  - b. Name your L5 valve.
3. **Power up your L5 device, follow the app instructions to connect your L5 to WiFi.** Make sure your local network is enabled if you are using iOS device.
4. **Configure your L5 valve.**
  - a. Set up water leak protection via wireless leak detectors.
  - b. Set up a maintenance cycle.

## INSTALLATION

1. Locate and turn off the water main valve.
2. Drain the remaining water in the pipe by opening several faucets in the home.
3. Install the L5 Water Valve on the main water line after your main water shutoff valve and the pressure reducing valve (if applicable).
  - Make sure the ball valve is in the open position before installation to ensure alignment with the actuator. See Fig. 3.

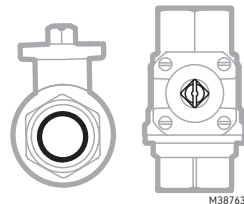

Fig. 3. Example of open ball valve.

4. Install the actuator on the ball valve and connect both with the supplied clip, as shown in the picture below.

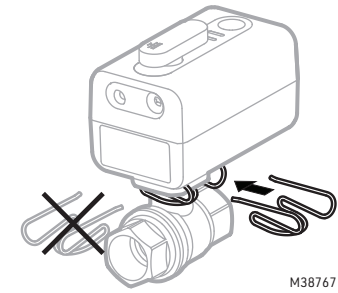

Fig. 4. Connect ball valve to actuator.

- Make sure the L5 Actuator is in the open position before installation to ensure alignment with the ball valve. To manually adjust the position: push the handle down and turn the handle 90 degrees to reach either the open or close position. After powering up the device, you may notice a slight position alignment forced by the motor.

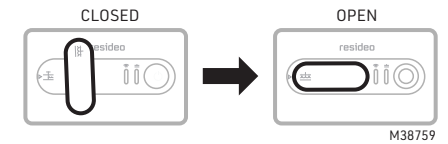

Fig. 5.

5. Carefully turn the water main valve back on and make sure there is no leakage at the installation.
6. Turn off the faucets and check the installation again to make sure there is no leakage spotted.
7. Connect the power adapter for the actuator. Wait for the actuator to connect online. Make sure the power LED is showing a green color and the WiFi LED is showing blue.
8. Your installation is completed.

## LED STATUS

Table 1. Valve LED Status Light.

Description		LED Status
M38787	Valve Open	Solid Green
	Valve Closed	Solid Red
	Valve Opening	Blinking Green
	Valve Closing	Blinking Red
	Error State	Blinking Red and Green

Table 2. WiFi LED Status Light.

Description		LED Status
M38786	WiFi not Connected	Off
	In Pairing Mode	Blinking Blue
	WiFi Connected, No Cloud Connection	Solid Blue
	WiFi Connected, Cloud Connection Established	Solid Blue, But Blinks Every 5s

## VALVE CLOSE / OPEN

### Valve Close

1. Push the power button on L5 WiFi Water Leak Shutoff Valve, or tap the close command in the app's menu.



Fig. 6.

2. The valve closing process is initiated. The status LED is pulsing red.
3. The valve is closed. The status LED is solid red.

### Valve Open

1. Push the power button on L5 WiFi Water Leak Shutoff Valve, or tap the open command in the app's menu.
2. The valve opening process is initiated. The status LED is pulsing green.
3. The valve is open. The status LED is solid green.

## EMERGENCY BALL VALVE CLOSE / OPEN

The handle on the L5 actuator is intended to be used for emergencies only. For example, during a power outage. Please follow the steps below if you need to use the emergency handle:

1. Unplug the L5 WiFi Water Leak Shutoff Valve from the power supply.
2. Push on the lever until it touches the actuator's top cover. You should feel minimum resistance. This step is important to allow the handle to be detached from the gearbox.
3. While pushing down the handle, turn the lever clockwise to close the ball valve. You may feel some resistance just like when you are closing a regular ball valve.
4. To open the valve, push down the handle while turning it counterclockwise. You may feel some resistance just like when you are opening a regular brass ball valve.

### IMPORTANT

Since the handle is intended to be used in emergencies only, when using the emergency handle to close the valve, the valve status change does not synchronize with the app.

## PAIR L5 WITH WATER SENSOR(S)

L5 works with both Resideo's new L1 and the original WiFi Water Leak and Freeze Detector. The detector(s) and L5 need to be set up in the same location in the app in order for the devices to be paired with each other.

You can choose which specific detector(s) you want to enable L5's automatic shutoff function. You can change the setting at any time under "LEAK PROTECTION". This can be found on the bottom of L5's home page in the app, or as a first time user, you will be taken through the setup of this function automatically.

## MAINTENANCE CYCLE

This function can be found under "Settings" or you will automatically be taken through the setup process as a first time user. It's designed to close, then immediately open your L5 valve regularly to prevent the valve gets stuck. We recommend you set the maintenance cycle to take place at least every 2 months.

### IMPORTANT

- To prevent unintended water supply, the valve maintenance cycle will not perform when the valve is in the closed position.
- If you are considering having the valve permanently closed, manually open, then close the valve at least every 2 months.

## SYNCHRONIZE THE VALVE POSITION WITH APP STATUS

If for any reason, the valve's position does not match the valve's status in the app, take the following steps to synchronize the valve with the app's status.

1. Unplug the actuator from the power supply.
2. Plug back in the power supply. Once the L5 Actuator is powered back up, it will operate the valve to the last known position. Wait a few minutes until the status LED is either solid red or solid green.
3. Now you should be able to see the valve status in the app is aligned with the actual valve status.

## TECHNICAL SPECIFICATIONS

### Dimensions

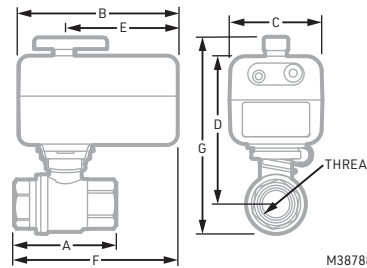

Fig. 7. Dimension diagram.

Table 3. Dimensions.

Model	A	B	C	D	E	F	G	Thread	Power Supply Length
	Inch (mm)	Inch (mm)	Inch (mm)	Inch (mm)	Inch (mm)	Inch (mm)	Inch (mm)		Inch (m)
VWS01Y-1/2 VWS02Y-1/2	2.598 (66)	4.567 (116)	2.677 (68)	3.976 (101)	3.228 (82)	4.606 (117)	5.157 (131)	NPT 1/2 Inch	118 (3)
VWS01Y-3/4 VWS02Y-3/4	2.953 (75)	4.567 (116)	2.677 (68)	4.252 (108)	3.228 (82)	4.685 (119)	5.669 (144)	NPT 3/4 Inch	118 (3)
VWS01Y-1 VWS02Y-1	3.583 (91)	4.567 (116)	2.677 (68)	4.409 (112)	3.228 (82)	5.000 (127)	5.984 (152)	NPT 1 Inch	118 (3)
VWS01Y- 11/4 VWS02Y-11/4	4.094 (104)	4.567 (116)	2.677 (68)	4.685 (119)	3.228 (82)	5.276 (134)	6.496 (165)	NPT 1-1/4 Inch	118 (3)

### Power Adapter

Input: 100-240 V~, 50/60 Hz, 0.6 A

Insulation class power adapter: Class II double insulated power adapter

## REGULATORY INFORMATION

### FCC REGULATIONS

#### § 15.19 (a)(3)

This device complies with part 15 of the FCC Rules. Operation is subject to the following two conditions:

- 1 This device may not cause harmful interference, and
- 2 This device must accept any interference received, including interference that may cause undesired operation.

### IC REGULATIONS RSS-GEN

This device complies with Industry Canada's license-exempt RSSs. Operation is subject to the following two conditions:

- 1 This device may not cause interference; and
- 2 This device must accept any interference, including interference that may cause undesired operation of the device.

### FCC Warning (Part 15.21) (USA only)

Changes or modifications not expressly approved by the party responsible for compliance could void the user's authority to operate the equipment.

### RESIDEO-Extended Producer Responsibility

The product should not be disposed of with other household waste. Check for the nearest authorized collection centers or authorized recyclers. The correct disposal of end-of-life equipment will help prevent potential negative consequences for the environment and human health.

### Valve Certification

- NSF / ANSI 61
- NSF / ANSI 372
- CSA

## 5-YEAR LIMITED WARRANTY

For warranty information, go to [resideo.com](https://www.resideo.com)

## DISCLAIMER

- Product is not designed for continuous valve open/close operation. Valve close/open cycle should be performed max. once per 10 minutes to avoid product overheat.
- Product is designed for indoor use only.
- Valves, supplied as original accessory, are designed for potable water (drinking water).

## CAUTION

- When water is shut off by L5, it may cause damage to the appliances and accessories that are connected to the water main due to lack of water.
- Only for domestic water usage and to be installed indoors.
- Backflow preventers are required if used to control outside water supply lines.
- Must be installed down stream of pressure tank.
- Must NOT be installed on system with external hot water source.
- Must NOT install on fire sprinkler or suppression systems. Installation on fire sprinkler or suppression systems may cause it not to function in an emergency.

Full product manual is available at [www.resideo.com](https://www.resideo.com)



[www.resideo.com](https://www.resideo.com)

Resideo Technologies, Inc.  
1985 Douglas Drive North, Golden Valley, MN 55422  
1-800-468-1502  
33-00602-03 Rev. M.S. 09-22 | Printed in United States

© 2022 Resideo Technologies, Inc. All rights reserved.  
This product is manufactured by Resideo Technologies, Inc. and its affiliates.